

KABELSATZSCHEMA / WIRING HARNESS DIAGRAM

SCHEINWERFER-RECHTS
HEADLAMP-RIGHT

MASSEBAND
GROUND STRAP

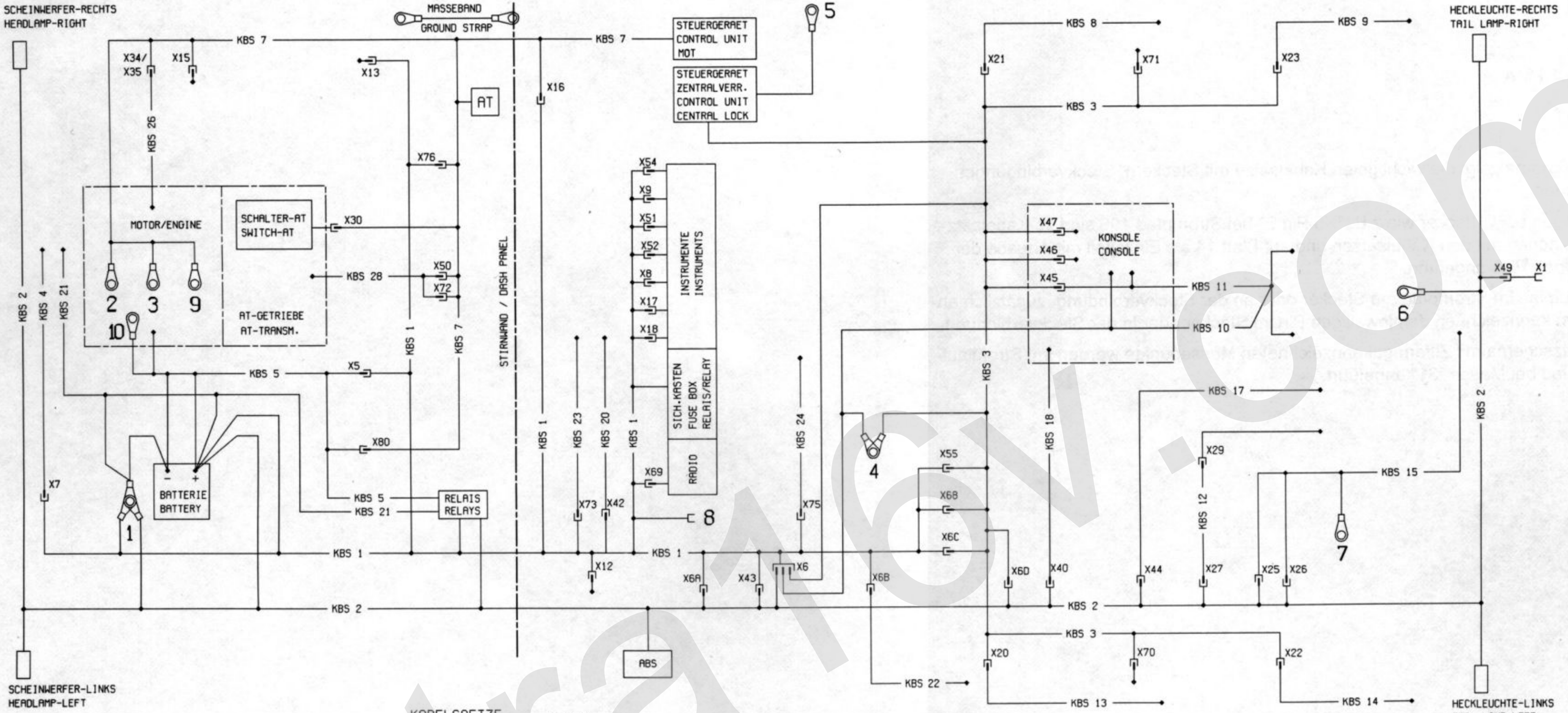

KABELSATZ (KBS)
WIRING HARNESS

- KBS 1 = ARMATURENTAFEL
- KBS 2 = KAROSSERIE
- KBS 3 = TUER
- KBS 4 = KLIMAPLANLAGE
- KBS 5 = MOTOR
- KBS 6 = -----
- KBS 7 = MOTRONIC & AT
- KBS 8 = BEIFAHRERTUER
- KBS 9 = TUER-HINTEN,RECHTS
- KBS 10 = KONSOLE (OHNE FENSTERHEBER)
- KBS 11 = KONSOLE (MIT FENSTERHEBER)
- KBS 12 = WAGENHOEHNREGULIERUNG
- KBS 13 = FAHRERTUER
- KBS 14 = TUER-HINTEN, LINKS
- KBS 15 = DECKEL-HECKRAUM
- KBS 16 = -----
- KBS 17 = LAUTSPRECHER-HINTEN, ANTENNE
- KBS 18 = KONSOLE MT/AT
- KBS 19 = -----

- INSTRUMENT PANEL
BODY
- MOTRONIC & AT
 - COODRIVER DOOR
 - DOOR-REAR, RIGHT
 - CONSOLE (WITHOUT WINDOW LIFTER)
 - CONSOLE (WITH WINDOW LIFTER)
 - CAR LEVEL CONTROL
 - DRIVER DOOR
 - DOOR-REAR, LEFT
 - LID-TRUNK
 -
 - LOUDSPEAKER-REAR, ANTENNA
 - CONSOLE MT/AT
 -

- KBS 20 = GESCHWINDIGKEITSREGLER
- KBS 21 = GEBLAESE, HOCHLEISTUNG
- KBS 22 = FAHRWERKABSTIMMUNG, HINTEN
- KBS 23 = SCHALTER-KICK DOWN
- KBS 24 = SICHERHEITSKONTROLLE (SA)
- KBS 25 = -----
- KBS 26 = VENTILE-KRAFTSTOFFEINSPRITZUNG
- KBS 27 = -----
- KBS 28 = AT-GETRIEBE AR25/35 & MOT

- CRUISE CONTROL
BLOWER, HEAVY DUTY
RIDE CONTROL, REAR
SWITCH-KICK DOWN
SAFETY CHECKING (SA)
- - VALVES-FUEL INJECTION
 -
 - AT-TRANSMISSION AR25/35 & MOT

MASSEPUNKTE 31-
GROUND POINTS

- 1 = KAROSSERIE-VORN, LINKS
 - 2 = MOTOR-EINLASSKRUEMMER (MOT)
 - 3 = MOTOR-EINLASSKRUEMMER (MOT)
 - 4 = SEITENTEIL-STIRNwand, LINKS
 - 5 = SEITENTEIL-STIRNwand, RECHTS
 - 6 = KAROSSERIE-HINTEN, MITTE
 - 7 = KAROSSERIE-HINTEN, LINKS
 - 8 = HALTER-LENKUNG
 - 9 = MOTOR-EINLASSKRUEMMER
 - 10 = MOTORBLOCK
- BODY-FRONT, LEFT
 - ENGINE-INTAKE MANIFOLD (MOT)
 - ENGINE-INTAKE MANIFOLD (MOT)
 - PANEL-SHROUD SIDE, LEFT
 - PANEL-SHROUD SIDE, RIGHT
 - BODY-REAR, CENTER
 - BODY-REAR, LEFT
 - BRACKET-STEERING COLUMN
 - ENGINE-INTAKE MANIFOLD
 - ENGINE BLOCK

STECKVERBINDUNGEN / CONNECTIONS

X1	STECKDOSE-ANHÄNGER 7P	SOCKET-TRAILER 7P
X5	ARMATURENTAFEL & MOTOR 7P	INSTRUMENT PANEL & ENGINE 7P
X6	ARMATURENTAFEL & KAROSSERIE/TUER 51P	INSTRUMENT PANEL & BODY/DOOR 51P
X6A	ARMATURENTAFEL & KAROSSERIE 6P (BR)	INSTRUMENT PANEL & BODY 6P (BR)
X6B	ARMATURENTAFEL & FAHRERKRABSTIMMUNG, HINTEN 6P	INSTRUMENT PANEL & RIDE CONTROL, REAR 6P
X6C	ARMATURENTAFEL & TUER 4P	INSTRUMENT PANEL & DOOR 4P
X6D	KAROSSERIE & TUER 6P (ZV)	BODY & DOOR 6P (ZV)
X7	ARMATURENTAFEL & KLIMANLAGE 7P	INSTRUMENT PANEL & AIR CONDITIONING 7P
X8	ARMATURENTAFEL & LCD-INSTRUMENT 26P	INSTRUMENT PANEL & LCD-INSTRUMENT 26P
X9	ARMATURENTAFEL & LCD-INSTRUMENT 26P (CC)	INSTRUMENT PANEL & LCD-INSTRUMENT 26P (CC)
X10	CODIERUNG-LÄENDER 6P	CODE-COUNTRIES 6P
X11	ARMATURENTAFEL & GEBER, TEMPERATUR 2P (J)	INSTRUMENT PANEL & SENSOR, TEMPERATURE 2P (J)
X12	CODIERUNG-DWA 4P	CODE-ANTI THEFT WARN U. 4P
X13	DIAGNOSE 10P	DIAGNOSTIC LINK 10P
X15	OKTANZAHL 3P	OCTANE NUMBER 3P
X16	ARMATURENTAFEL & MOTRONIC 26P	INSTRUMENT PANEL & MOTRONIC 26P
X17	ARMATURENTAFEL & INSTRUMENT 14P	INSTRUMENT PANEL & INSTRUMENT 14P
X18	ARMATURENTAFEL & INSTRUMENT 16P	INSTRUMENT PANEL & INSTRUMENT 16P
X20	TUER & FAHRERTUER 24P	DOOR & DRIVER DOOR 24P
X21	TUER & BEIFAHRERTUER 24P	DOOR & CO-DRIVER DOOR 24P
X22	TUER & TUER-HINTEN, LINKS 11P	DOOR & DOOR-REAR, LEFT 11P
X23	TUER & TUER-HINTEN, RECHTS 11P	DOOR & DOOR-REAR, RIGHT 11P
X25	KAROSSERIE & DECKEL-HECKRAUM 4P	BODY & LID-TRUNK 4P
X26	KAROSSERIE & DECKEL-HECKRAUM 3P	BODY & LID-TRUNK 3P
X27	KAROSSERIE & WAGENHOEHNREGULIERUNG 3P	BODY & CAR LEVEL CONTROL 3P
X29	WAGENHOEHNREGULIERUNG & HOEHNENDEBER 5P	CAR LEVEL CONTROL & HEIGHT SENSOR 5P
X30	MOTRONIC & SCHALTER-AT 8P	MOTRONIC & SWITCH-AT 8P
X34	MOTRONIC & EINSPRITZVENTILE-KRAFTST. 3P (C26NE)	MOTRONIC & INJECTION VALVES-FUEL 3P (C26NE)
X35	MOTRONIC & EINSPRITZVENTILE-KRAFTST. 15P (C26NE)	MOTRONIC & INJECTION VALVES-FUEL 15P (C26NE)
X40	KAROSSERIE & KONSOLE 8P (MT/AT)	BODY & CONSOLE 8P (MT/AT)
X42	ARMATURENTAFEL & GESCHWINDIGKEITSREGLER 4P (AT)	INSTRUMENT PANEL & CRUISE CONTROL 4P (AT)
X43	ARMATURENTAFEL & KAROSSERIE 6P	INSTRUMENT PANEL & BODY 6P
X44	KAROSSERIE & LAUTSPRECHER, HINTEN 6P	BODY & LOUDSPEAKER, REAR 6P
X45	TUER & KONSOLE 5P (FH)	DOOR & CONSOLE 5P (FH)
X46	TUER & KONSOLE 8P (FH)	DOOR & CONSOLE 8P (FH)
X47	TUER & KONSOLE 7P (FH)	DOOR & CONSOLE 7P (FH)
X49	KAROSSERIE & STECKDOSE-ANHÄNGER 9P	BODY & SOCKET-TRAILER 9P
X50	MOTRONIC & AUTOMATIKGETRIEBE 10P	MOTRONIC & AUTOMATIC TRANSMISSION 10P
X51	ARMATURENTAFEL & CHECK CONTROL 16P	INSTRUMENT PANEL & CHECK CONTROL 16P
X52	ARMATURENTAFEL & CHECK CONTROL 26P	INSTRUMENT PANEL & CHECK CONTROL 26P
X54	ARMATURENTAFEL & INSTRUMENT 8P (CC)	INSTRUMENT PANEL & INSTRUMENT 8P (CC)
X55	ARMATURENTAFEL & TUER 4P	INSTRUMENT PANEL & DOOR 4P
X66	FAHRERTUER & SCHALTER-AUSSENSPIEGEL 9P	DRIVER DOOR & SWITCH-OUTSIDE MIRROR 9P
X68	ARMATURENTAFEL & TUER 9P	INSTRUMENT PANEL & DOOR 9P
X69	ARMATURENTAFEL & RADIO 16P	INSTRUMENT PANEL & RADIO 16P
X70	TUER & GEBER-DWA 4P	DOOR & SENSOR-R/THF WRNG U. 4P
X71	TUER & GEBER-DWA 4P	DOOR & SENSOR-R/THF WRNG U. 4P
X72	MOTRONIC & AUTOMATIKGETRIEBE 2P	MOTRONIC & AUTOMATIC TRANSMISSION 2P
X73	ARMATURENTAFEL & SCHALTER-KICK DOWN 4P (LHD)	INSTRUMENT PANEL & SWITCH-KICK DOWN 4P (LHD)
X75	ARMATURENTAFEL & SICHERHEITSKONTROLLE 2P	INSTRUMENT PANEL & SAFETY CHECKING 2P
X76	ARMATURENTAFEL & MOTRONIC 2P	INSTRUMENT PANEL & MOTRONIC 2P
X77	KLIMANLAGE & DEBLAISE, KUEHLER 3P	AIR CONDITIONING & BLOWER, RADIATOR 3P
X80	MOTOR & MOTRONIC 2P (AT)	ENGINE & MOTRONIC 2P (AT)
X82	ARMATURENTAFEL & SCHALTER, DEBLAISE 2P	INSTRUMENT PANEL & SWITCH, BLOWER 2P
X83	ARMATURENTAFEL & GESCHWINDIGKEITSREGLER 1P	INSTRUMENT PANEL & CRUISE CONTROL 1P
X84	KAROSSERIE & GEBER-DREHZAHL, ABS 2P (VL)	BODY & SENSOR-REVOLUTION, ABS 2P (VL)
X85	KAROSSERIE & GEBER-DREHZAHL, ABS 2P (VR)	BODY & SENSOR-REVOLUTION, ABS 2P (VR)
X86	KAROSSERIE & GEBER-DREHZAHL, ABS 2P (HL)	BODY & SENSOR-REVOLUTION, ABS 2P (HL)
X87	KAROSSERIE & GEBER-DREHZAHL, ABS 2P (HR)	BODY & SENSOR-REVOLUTION, ABS 2P (HR)
* NICHT GEZEICHNET/NOT SHOWN		

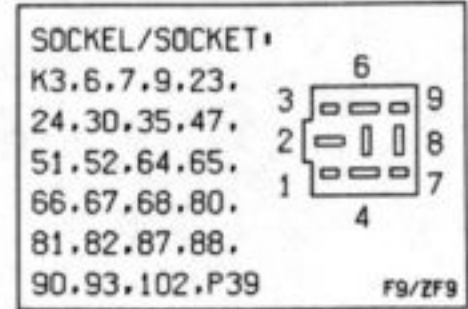
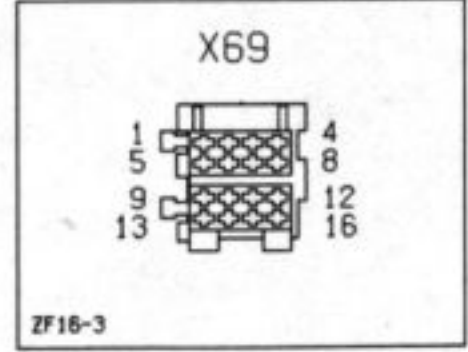
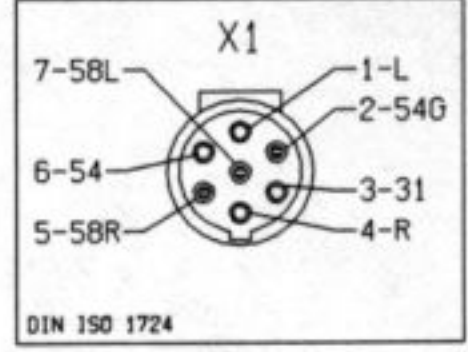
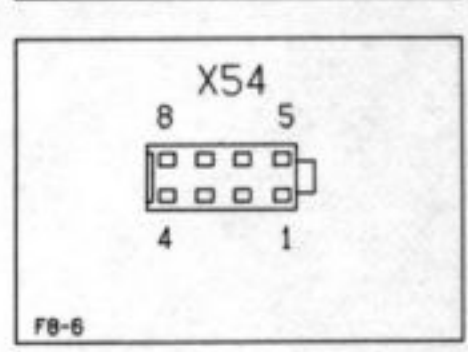
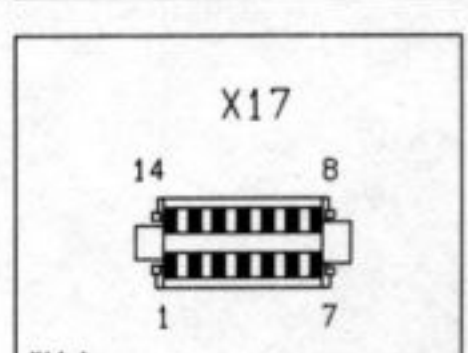
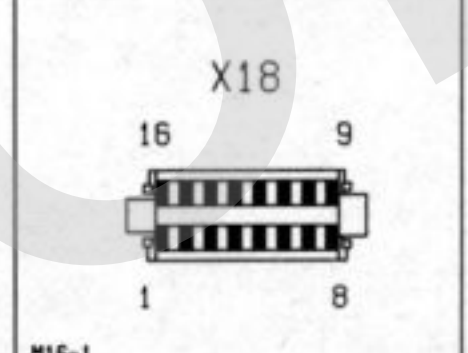
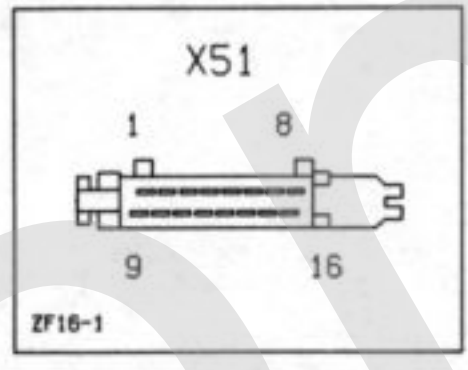
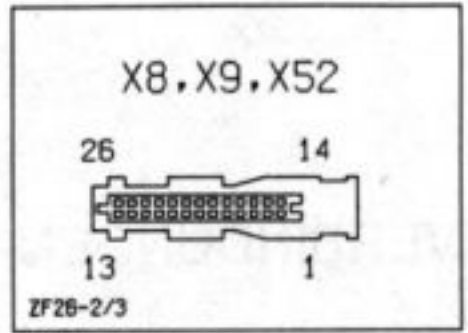
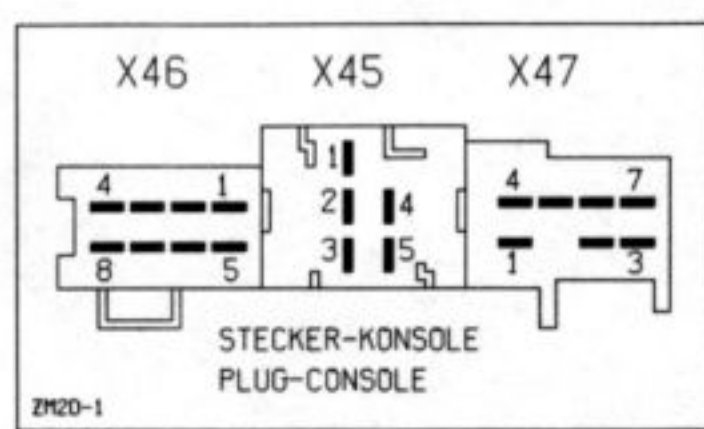
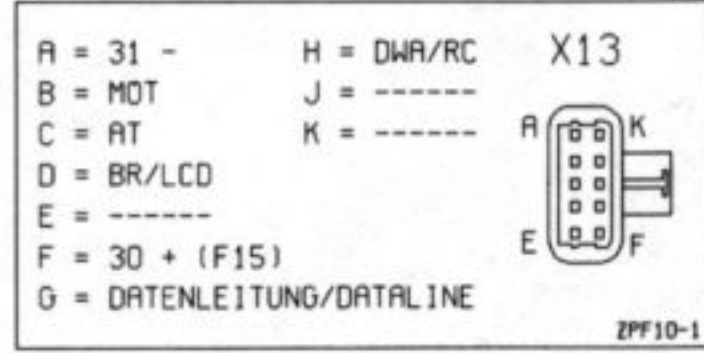
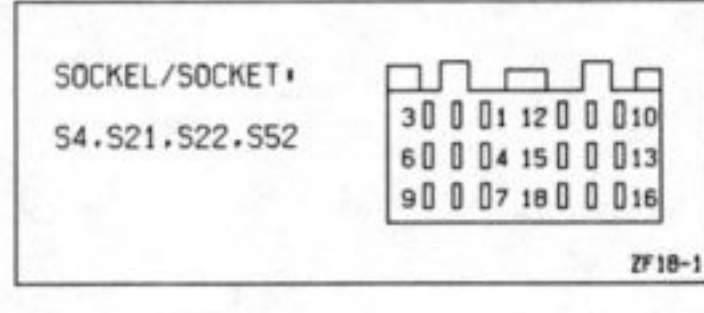
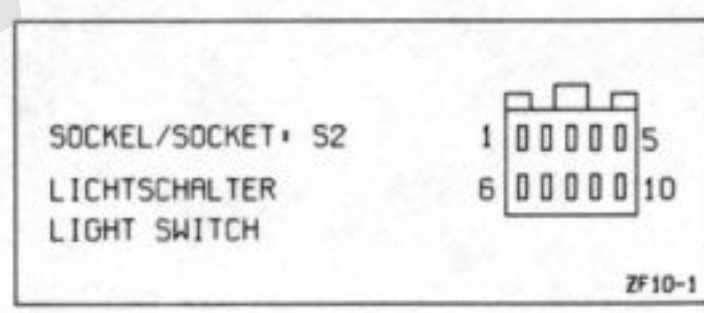
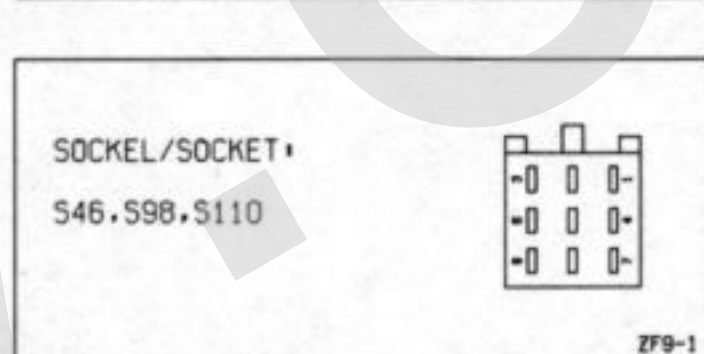
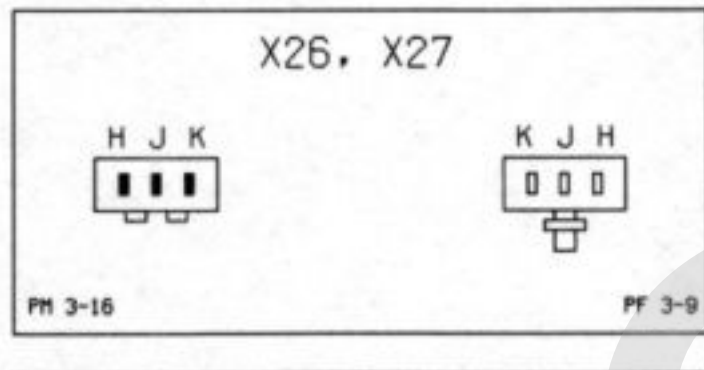
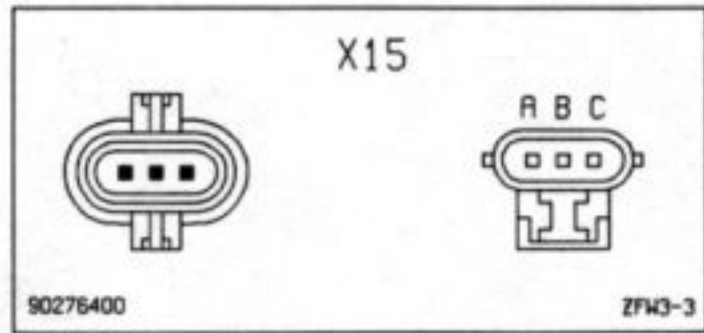
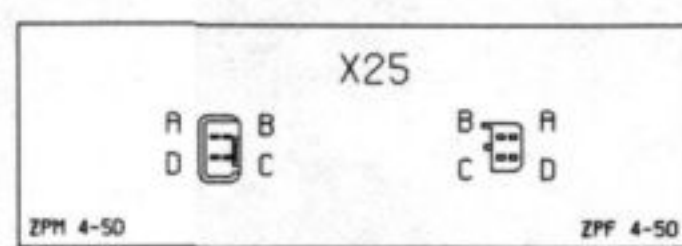
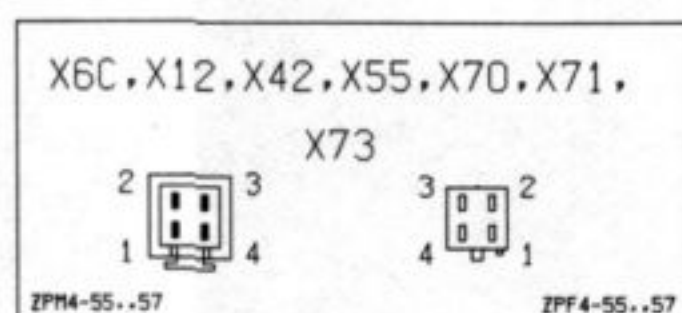
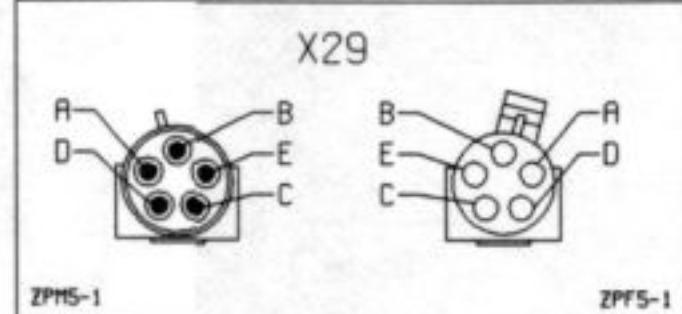
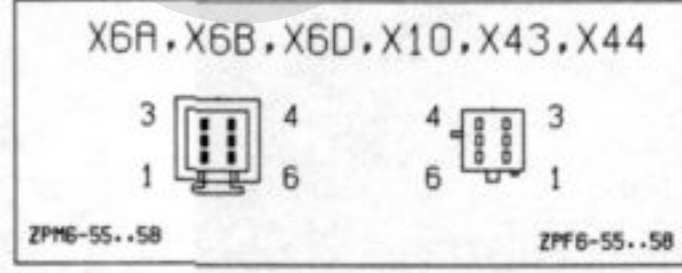
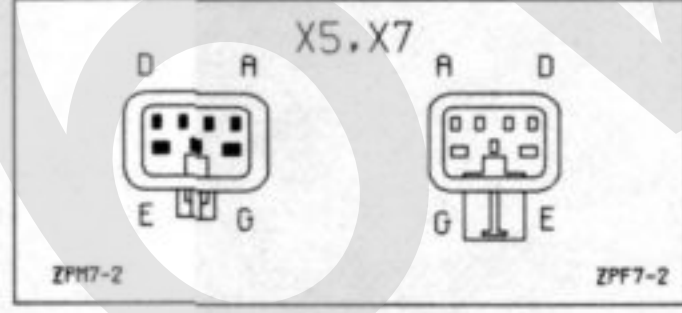
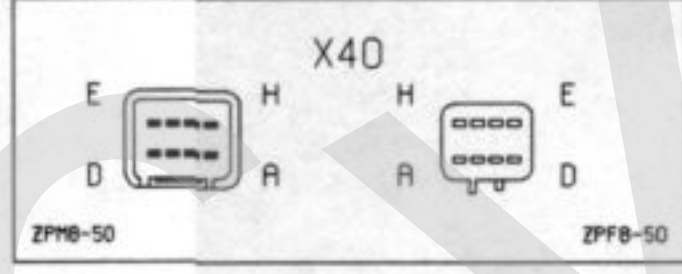
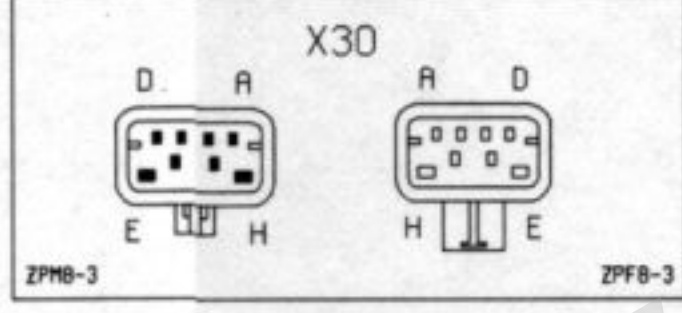
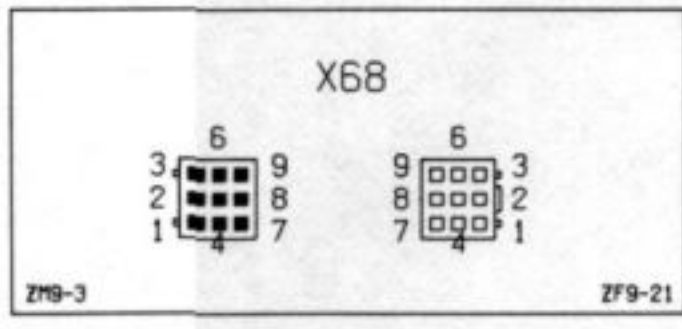
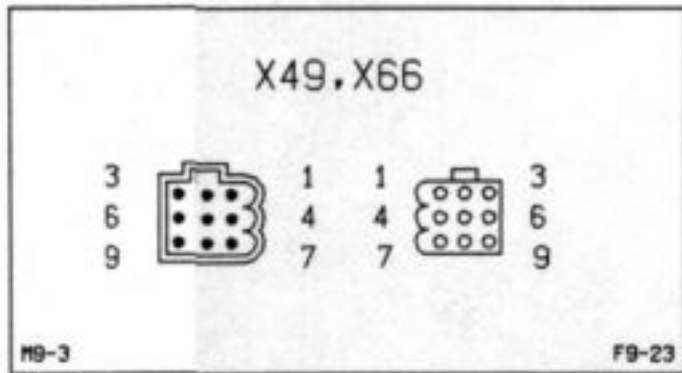
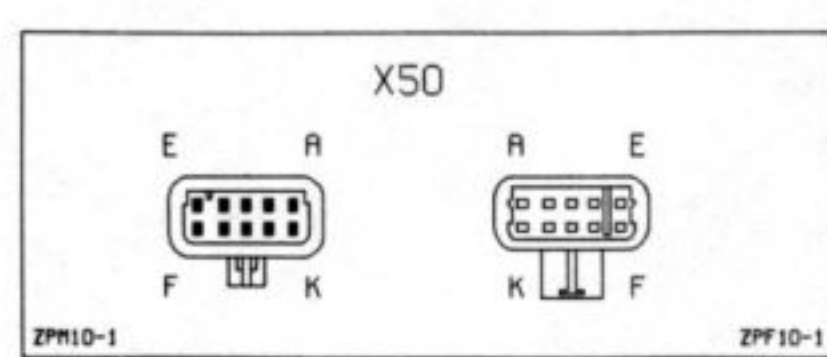
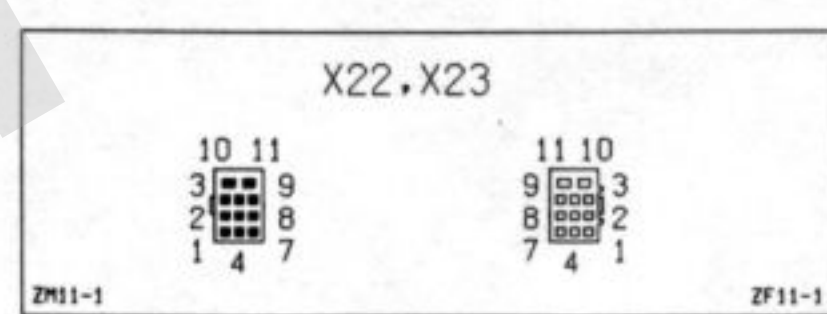
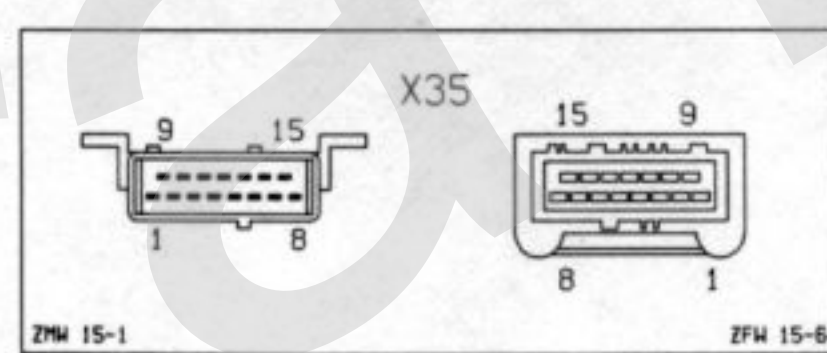
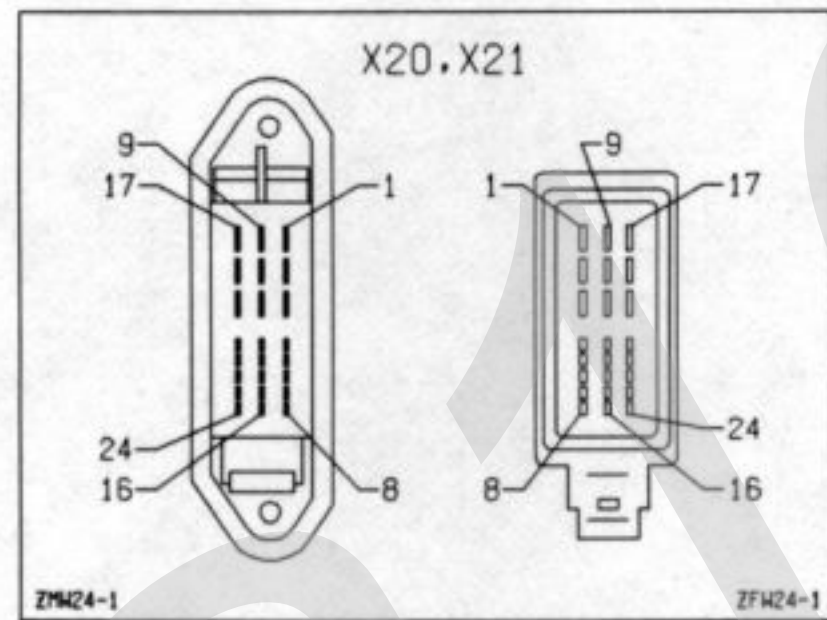
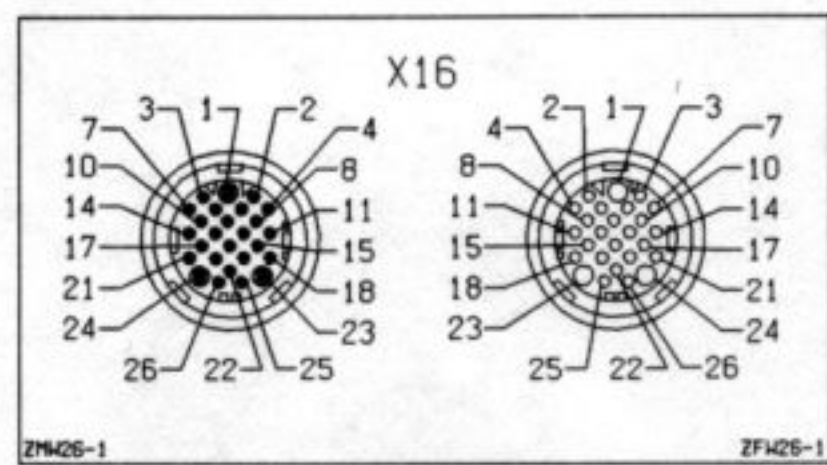
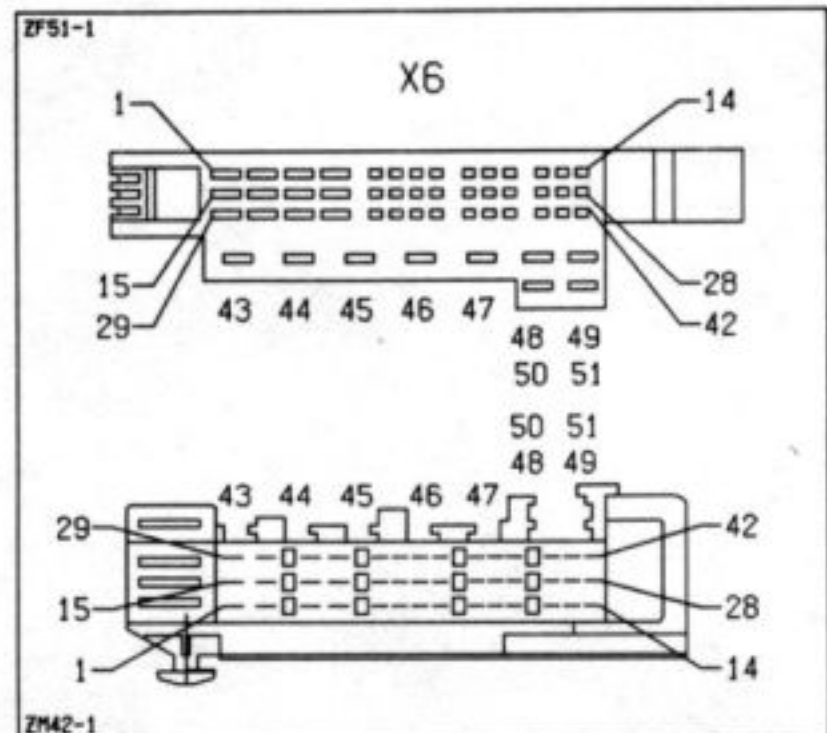

TEILEANORDNUNG / PARTS INSTALLATION

STEUERGERÄTE, RELAIS / CONTROL UNITS, RELAYS

		LHD	RHD		
K3	RELAIS-ANLASSER, DWA	B 3 H	E 3 H	SICHERUNGSKASTEN	FUSE BOX
K4	RELAIS-FERNSCHEINWERFER	B 3 H	E 3 H	SICHERUNGSKASTEN	FUSE BOX
K5	RELAIS-NEBELSCHEINWERFER	B 3 H	E 3 H	SICHERUNGSKASTEN	FUSE BOX
K6	RELAIS-KLIMAPLANZE	B 3 H	E 3 H	SICHERUNGSKASTEN	FUSE BOX
K7	RELAIS-DEBLAISE, KLIMAPLANZE	B 3 H	E 3 H	SICHERUNGSKASTEN	FUSE BOX
K8	RELAIS-INTERVALL, WISCHER, FRONTSCHIEBE	B 3 H	E 3 H	SICHERUNGSKASTEN	FUSE BOX
K9	RELAIS-WASCHERANLAGE, SCHEINWERFER	B 2 H	B 2 H	RELAISKASTEN	RELAY BOX
K10	BLINKDEBER	B 3 H	E 3 H	SICHERUNGSKASTEN	FUSE BOX
K14	REGLER-GESCHWINDIGKEIT	F 3 J	A 3 J	NEBEN HANDSCHUHFACH	BESIDE OF GLOVE BOX
K19	RELAIS-WAGENHOEHENREGULIERUNG	B 5 0	B 5 0	RAMPE-HINTERSITZ	RAMP-REAR SEAT
K21	DEBER-WAGENHOEHENREGULIERUNG	E 6 0	E 6 0	HINTERACHSE	REAR AXLE
K23	RELAIS-REGLER, GESCHWINDIGKEIT	B 3 H	E 3 H	SICHERUNGSKASTEN	FUSE BOX
K24	RELAIS-DEBLAISE, KUEHLER	B 2 H	B 2 H	RELAISKASTEN	RELAY BOX
K35	ZEITRELAIS-HECKSPEIBE & AUSSENSPIEGEL	B 3 H	E 3 H	SICHERUNGSKASTEN	FUSE BOX
K37	STEUERGERÄT-ZENTRALVERRIEGELUNG	F 3 H	F 3 H	HINTER VERKLEIDUNG-FUSSRAUM, SEITLICH	BEHIND MOULDING-LEG ROOM, SIDE
K41	STEUERGERÄT-HILFSKRAFTLENKUNG	B 3 H	E 3 H	FUSSRAUM, SEITLICH	LEG ROOM, SIDE
K47	RELAIS-UEBERSPANNUNGSSCHUTZ, ABS	B 2 H	B 2 H	RELAISKASTEN	RELAY BOX
K50	STEUERGERÄT-ABS	B 4 0	B 4 0	UNTER SITZ, LINKS	UNDER SEAT, LH
K51	RELAIS-DEBLAISE, KUEHLER	B 2 H	B 2 H	RELAISKASTEN	RELAY BOX
K52	RELAIS-DEBLAISE, KUEHLER	B 2 H	B 2 H	RELAISKASTEN	RELAY BOX
K59	RELAIS-TAGESFAHRLICHT	B 3 H	E 3 H	HALTER ARMATURENTAFEL	BRACKET INSTRUMENT PANEL
K61	STEUERGERÄT-MOTRONIC	F 3 H	F 3 H	HINTER VERKLEIDUNG-FUSSRAUM, SEITLICH	BEHIND MOULDING-LEG ROOM, SIDE
K63	RELAIS-FANFARE	B 3 H	E 3 H	SICHERUNGSKASTEN	FUSE BOX
K64	RELAIS-DEBLAISE, KLIMAPLANZE, 1. STUFE	B 3 H	E 3 H	SICHERUNGSKASTEN	FUSE BOX
K65	RELAIS-HEIZMATTE, RUECKSITZ, LINKS	C 5 0	C 5 0	RAMPE HINTERSITZ	RAMP REAR SEAT
K66	RELAIS-HEIZMATTE, RUECKSITZ, RECHTS	C 5 0	C 5 0	RAMPE HINTERSITZ	RAMP REAR SEAT
K67	RELAIS-DEBLAISE, KUEHLER	B 2 H	B 2 H	RELAISKASTEN	RELAY BOX
K68	RELAIS-EINSPRITZANLAGE, KRAFTSTOFF	F 3 H	F 3 H	HINTER VERKLEIDUNG-FUSSRAUM, SEITLICH	BEHIND MOULDING-LEG ROOM, SIDE
K71	STEUERGERÄT-FAHRWERKABSTIMMUNG	E 3 H	B 3 H	OBERHALB HANDSCHUHFACH	ABOVE GLOVE BOX
K85	STEUERGERÄT-AUTOMATIKGETRIEBE	E 2 J	B 2 J	IM WASSERKASTEN	IN WATER SEPARATION
K86	STEUERGERÄT-CHECK CONTROL	B 3 H	E 3 H	HALTER ARMATURENTAFEL	BRACKET INSTRUMENT PANEL
K87	RELAIS-DEBLAISE, KUEHLER	B 2 H	B 2 H	RELAISKASTEN	RELAY BOX
K88	STEUERGERÄT-TEMPERATUR, KATALYSATOR	B 3 H	E 3 H	HALTER ARMATURENTAFEL	BRACKET INSTRUMENT PANEL
K90	RELAIS-KOMPRESSOR (AT)	B 2 H	B 2 H	RELAISKASTEN	RELAY BOX
K93	RELAIS-KOMPRESSOR, MOTRONIC	B 2 H	B 2 H	RELAISKASTEN	RELAY BOX
K94	STEUERGERÄT-DIEBSTAHLWARNANLAGE	E 3 J	B 3 J	OBERHALB HANDSCHUHFACH	ABOVE GLOVE BOX
K101	RELAIS-SPIEGEL, PARKSTELLUNG	F 3 H	F 3 H	HINTER VERKLEIDUNG-FUSSRAUM, SEITLICH	BEHIND MOULDING-LEG ROOM, SIDE
K102	STEUERGERÄT-PBSL	B 3 H	E 3 H	HALTER ARMATURENTAFEL	BRACKET INSTRUMENT PANEL
H19	WARNSUMMER-SCHEINWERFEREINSCHALTUNGSKONTROLLE	B 3 H	E 3 H	SICHERUNGSKASTEN	FUSE BOX
H27	WARNSUMMER-SICHERHEITSKONTROLLE	B 3 H	E 3 H	HALTER ARMATURENTAFEL	BRACKET INSTRUMENT PANEL
P14	DEBER-WEGSTRECKE (NUR LCD)	C 3 0	C 3 0	GETRIEBE	GEAR BOX
P25	DEBER-GLUEHLAMPENKONTROLLE	B 3 H	E 3 H	HALTER ARMATURENTAFEL	BRACKET INSTRUMENT PANEL
P39	DEBER-GLUEHLAMPENKONTROLLE, ANHÄNGER	A 7 J	A 7 J	HINTER VERKLEIDUNG-SEITENWAND	BEHIND MOULDING-SIDE

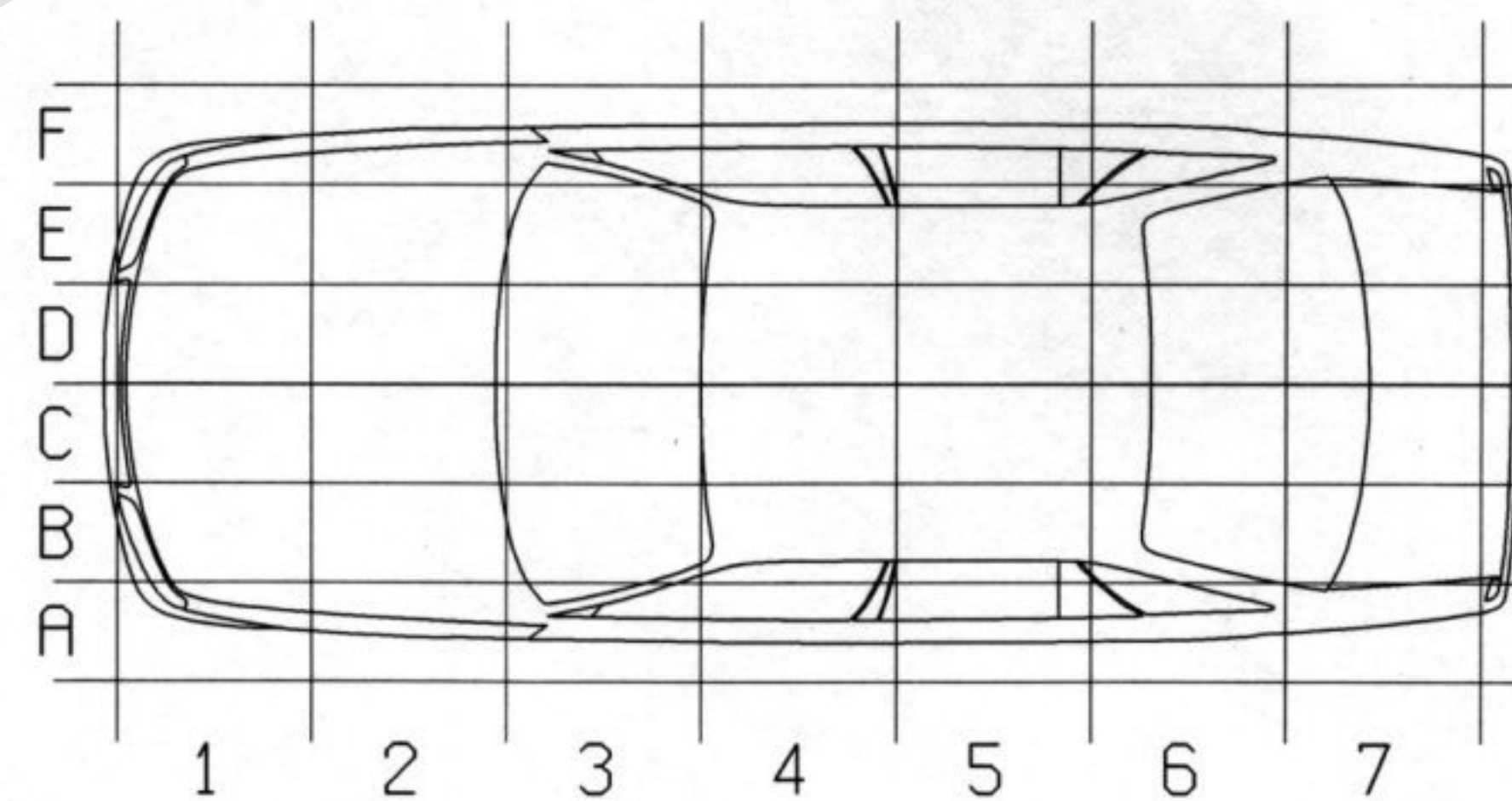
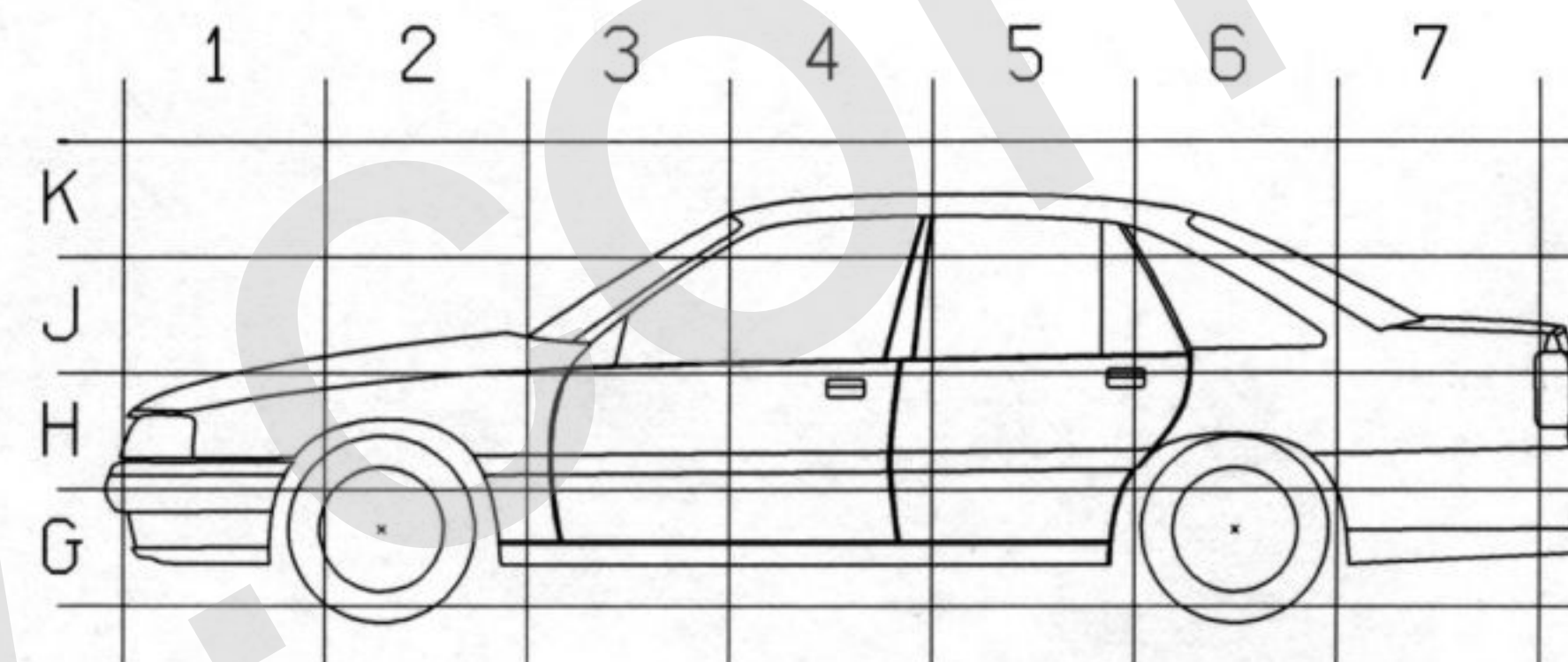

SICHERUNGEN / FUSES

		LHD	RHD		
F1-F30	SICHERUNGEN				
F31	SICHERUNG-DEBLAISE, KUEHLER	B 3 H	E 3 H	SICHERUNGSKASTEN	FUSE BOX
F34	SICHERUNG-DEBLAISE, KUEHLER	B 2 H	B 2 H	RELAISKASTEN	RELAY BOX
F38	SICHERUNG-DIEBSTAHLWARNANLAGE	B 2 H	B 2 H	RELAISKASTEN	RELAY BOX
F42	SICHERUNG-DEBLAISE, KUEHLER (MAXI)	B 3 H	E 3 H	SICHERUNGSKASTEN	FUSE BOX
F47	SICHERUNG-KLIMAPLANZE (MAXI)	B 2 H	B 2 H	RELAISKASTEN	RELAY BOX
	FUSES				
	FUSE-BLOWER, RADIATOR	B 3 H	E 3 H	SICHERUNGSKASTEN	FUSE BOX
	FUSE-BLOWER, RADIATOR	B 2 H	B 2 H	RELAISKASTEN	RELAY BOX
	FUSE-ANTI THEFT WARNING UNIT	B 3 H	E 3 H	SICHERUNGSKASTEN	FUSE BOX
	FUSE-BLOWER, RADIATOR (MAXI)	B 2 H	B 2 H	RELAISKASTEN	RELAY BOX
	FUSE-AIR CONDITIONING (MAXI)	B 2 H	B 2 H	RELAISKASTEN	RELAY BOX

STECKVERBINDUNGEN KABELSAETZE / PLUG CONNECTIONS WIRING HARNESSSES

		LHD	RHD		
X5	ARMATURENTAFEL & MOTOR 7P/14P (D)	C 2 J	C 2 J	STIRNWAND	DASH PANEL
X6	ARMATURENTAFEL & KAROSSERIE 51P	A 3 0	A 3 0	HINTER VERKLEIDUNG-FUSSRAUM, SEITLICH	BEHIND MOULDING-LEG ROOMSIDE
X6A	ARMATURENTAFEL & KAROSSERIE 6P	A 3 H	A 3 H	HINTER VERKLEIDUNG-FUSSRAUM, SEITLICH	BEHIND MOULDING-LEG ROOMSIDE
X6C	ARMATURENTAFEL & KAROSSERIE 4P	A 3 H	A 3 H	HINTER VERKLEIDUNG-FUSSRAUM, SEITLICH	BEHIND MOULDING-LEG ROOMSIDE
X6D	KAROSSERIE & TÜR 6P (ZV)	A 3 0	A 3 0	HINTER VERKLEIDUNG-FUSSRAUM, SEITLICH	BEHIND MOULDING-LEG ROOMSIDE
X10	CODIERUNG - LAENDER 6P	B 3 H	E 3 H	SICHERUNGSKASTEN	FUSE BOX
X13	DIAGNOSE LINK 10P	F 2 J	F 2 J	RADEINBAU	WHEELHOUSE
X15	OKTANZAHL 3P	F 2 J	F 2 J	RADEINBAU	WHEELHOUSE