

KABELSATZSCHEMA / WIRING HARNESS DIAGRAM

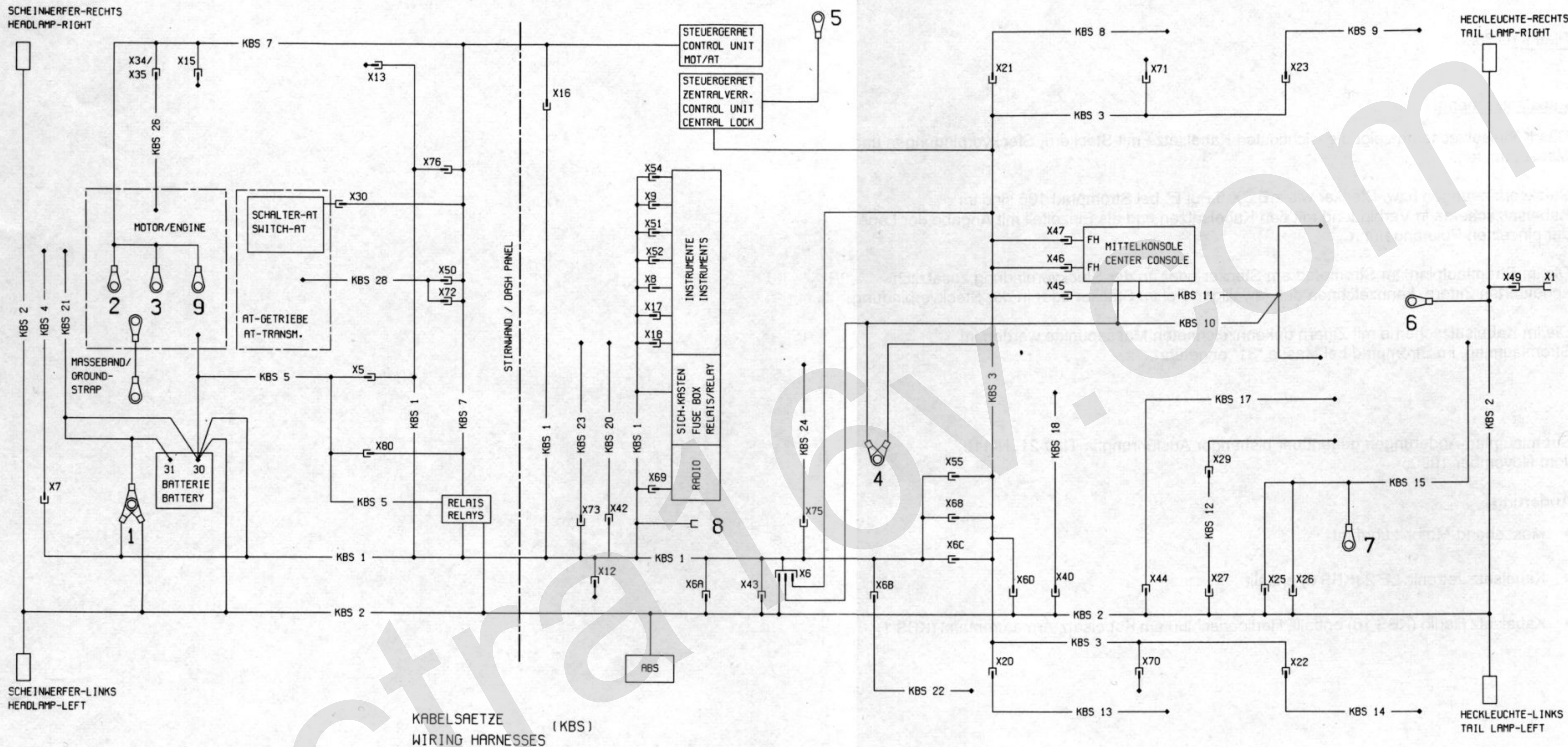

KABELSAETZE (KBS) WIRING HARNESSES

MASSEPUNKTE (MASSEPUNKTE) 31- GROUND POINTS

- KBS 1 = ARMATURENTAFEL
- KBS 2 = KAROSSERIE
- KBS 3 = TUEER
- KBS 4 = KLIMAPLANLAGE
- KBS 5 = MOTOR
- KBS 6 = -----
- KBS 7 = MOTRONIC
- KBS 8 = BEIFAHRERTUEER
- KBS 9 = TUEER-HINTEN,RECHTS
- KBS 10 = KONSOLE (OHNE FENSTERHEBER)
- KBS 11 = KONSOLE (MIT FENSTERHEBER)
- KBS 12 = WAGENHOEHENREGULIERUNG
- KBS 13 = FAHRERTUEER
- KBS 14 = TUEER-HINTEN,LINKS
- KBS 15 = DECKEL-HECKRAUM
- KBS 16 = -----
- KBS 17 = LAUTSPRECHER-HINTEN,ANTENNE
- KBS 18 = KONSOLE MT/AT
- KBS 19 = -----

- INSTRUMENT PANEL
- BODY
- DOOR
- AIR CONDITIONING
- ENGINE
- 
- MOTRONIC
- CO-DRIVER DOOR
- DOOR-REAR,RIGHT
- CONSOLE (WITHOUT WINDOW LIFTER)
- CONSOLE (WITH WINDOW LIFTER)
- CAR LEVEL CONTROL
- DRIVER DOOR
- DOOR-REAR,LEFT
- LID-TRUNK
- 
- LOUDSPEAKER-REAR,ANTENNA
- CONSOLE MT/AT
- 

- KBS 20 = GESCHWINDIGKEITSREGLER
- KBS 21 = GEBLÄSE,HOCHLEISTUNG
- KBS 22 = FAHRWERKABSTIMMUNG,HINTEN
- KBS 23 = SCHALTER-KICK DOWN
- KBS 24 = SICHERHEITSKONTROLLE,SA
- KBS 25 = -----
- KBS 26 = VENTILE-KRAFTSTOFFEINSPRITZUNG
- KBS 28 = AT-GETRIEBE AR25/35

- CRUISE CONTROL
- BLOWER,HEAVY DUTY
- RIDE CONTROL,REAR
- SWITCH-KICK DOWN
- SAFETY CHECKING,SA
- 
- VALVES-FUEL INJECTION
- AT-TRANSMISSION AR25/35

- 1 = KAROSSERIE-VORN,LINKS
- 2 = MOTOR-EINLASSKRUEMMER (MOT)
- 3 = MOTOR-EINLASSKRUEMMER (MOT)
- 4 = SEITENTEIL-STIRNWAND,RECHTS
- 5 = SEITENTEIL-STIRNWAND,RECHTS
- 6 = KAROSSERIE-HINTEN,MITTE
- 7 = KAROSSERIE-HINTEN,LINKS
- 8 = HALTER-LENKUNG
- 9 = MOTOR-EINLASSKRUEMMER

- BODY-FRONT,LEFT
- ENGINE-INTAKE MANIFOLD (MOT)
- ENGINE-INTAKE MANIFOLD (MOT)
- PANEL-SHROUD SIDE,LEFT
- PANEL-SHROUD SIDE,RIGHT
- BODY-REAR,CENTER
- BODY-REAR,LEFT
- BRACKET-STEERING COLUMN
- ENGINE-INTAKE MANIFOLD

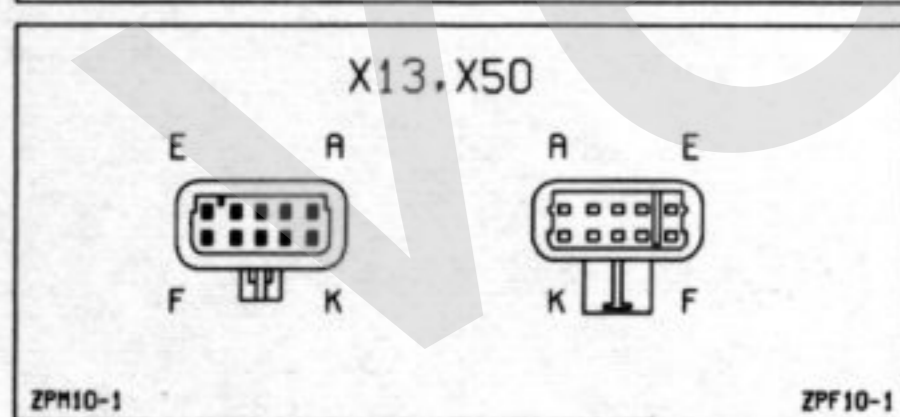
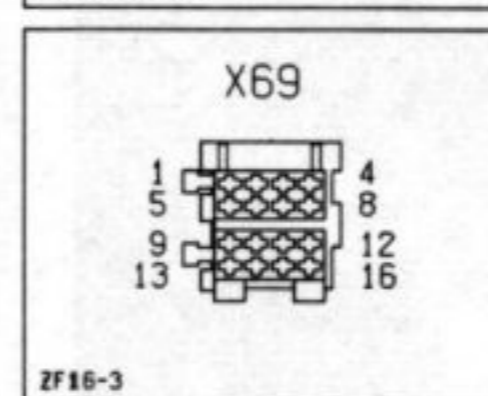
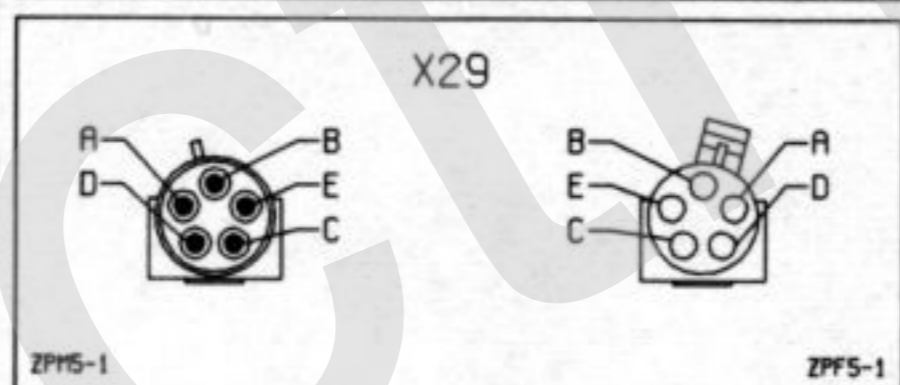
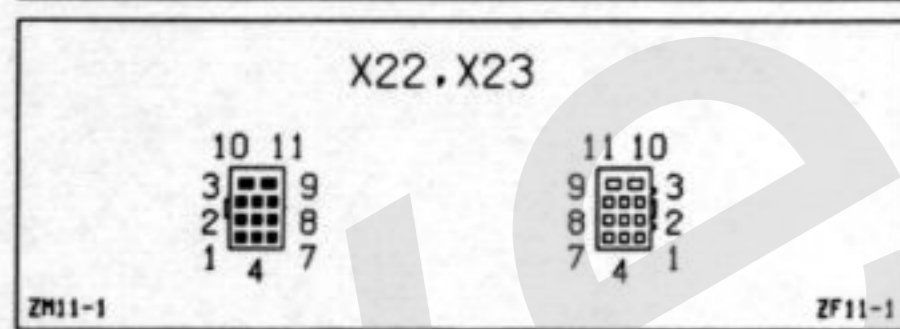
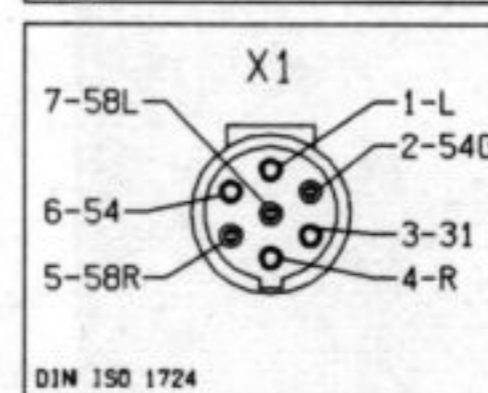
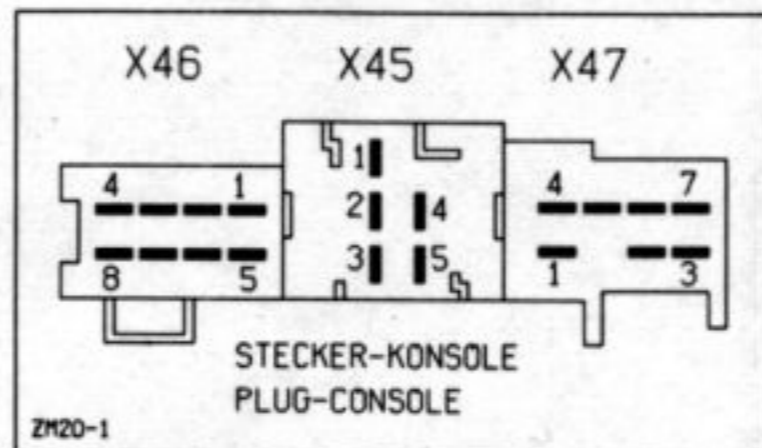
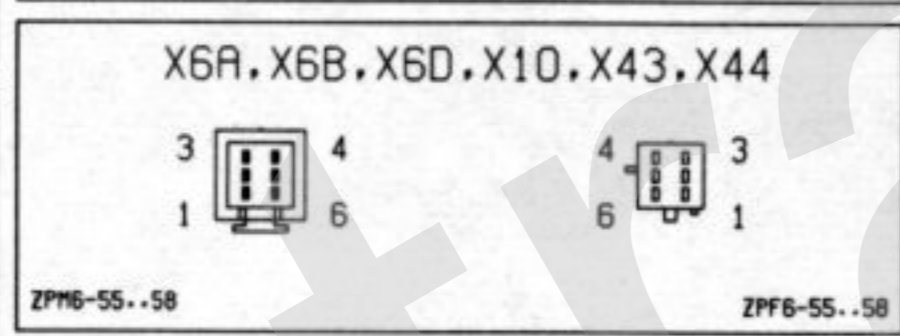
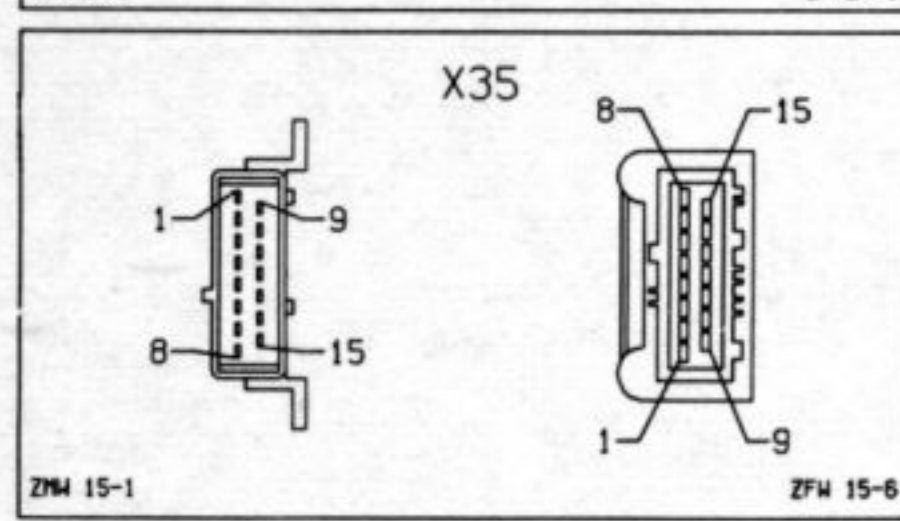
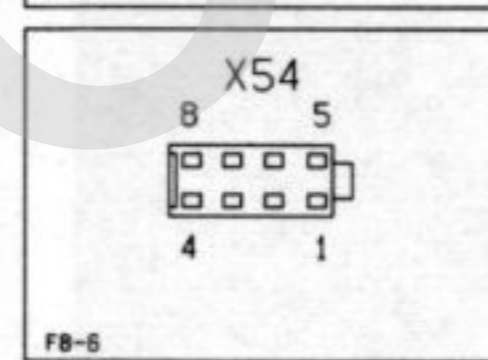
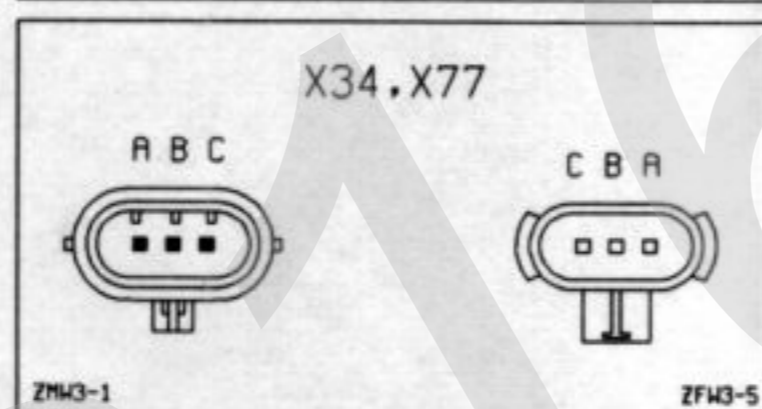
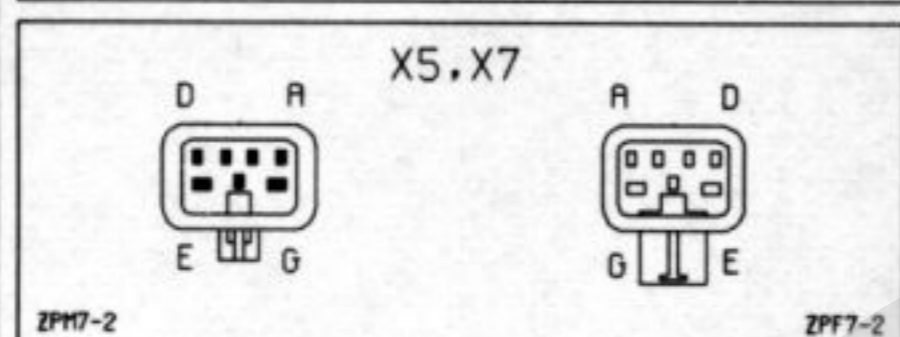
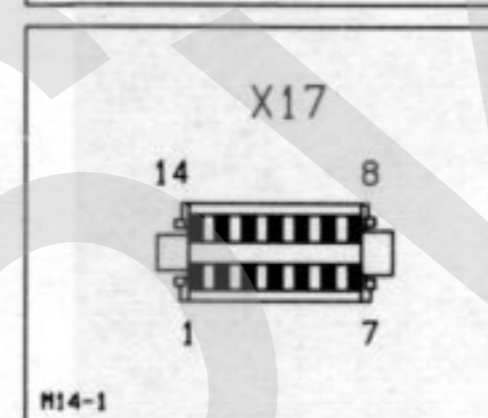
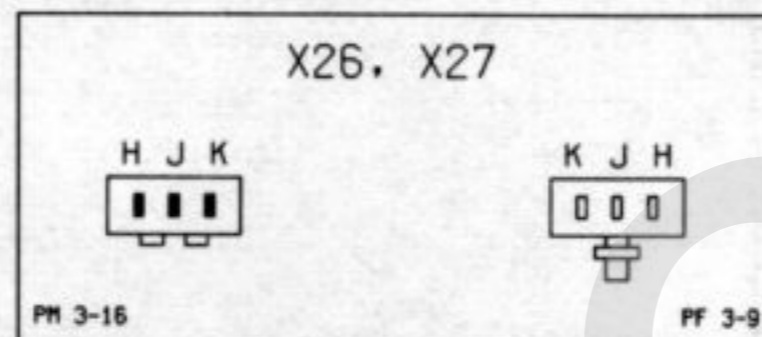
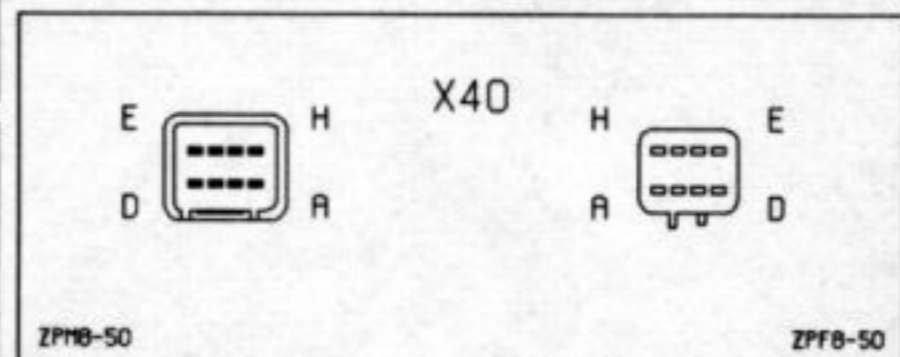
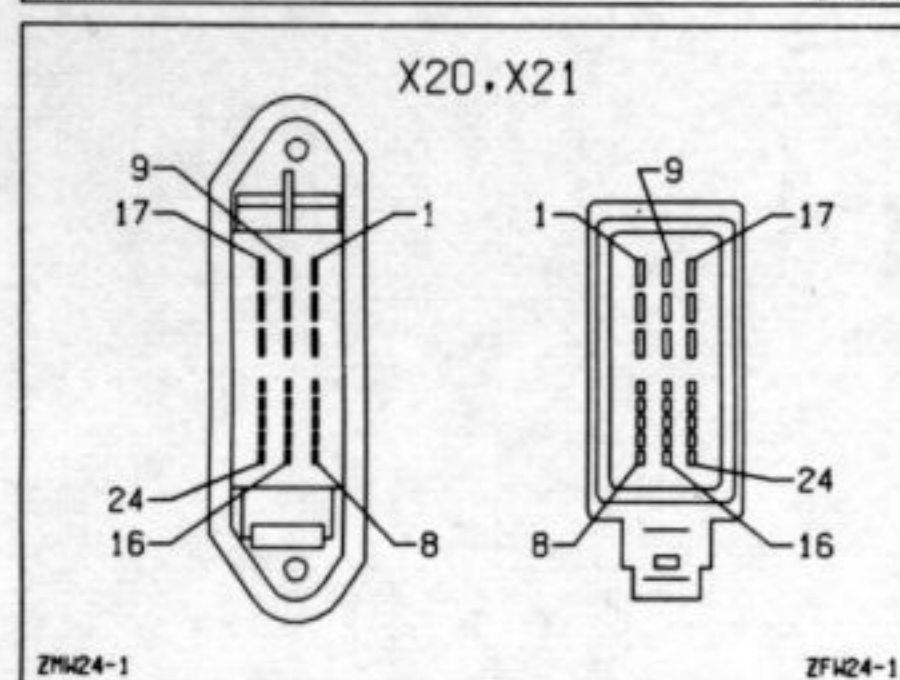
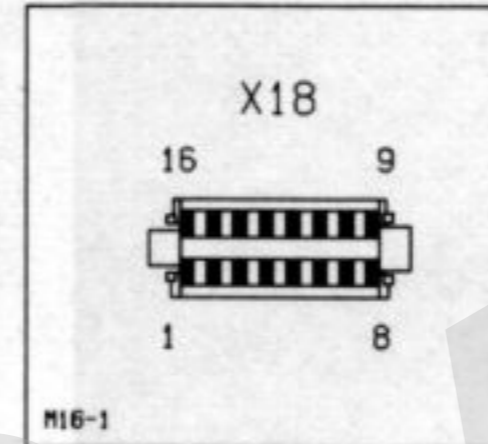
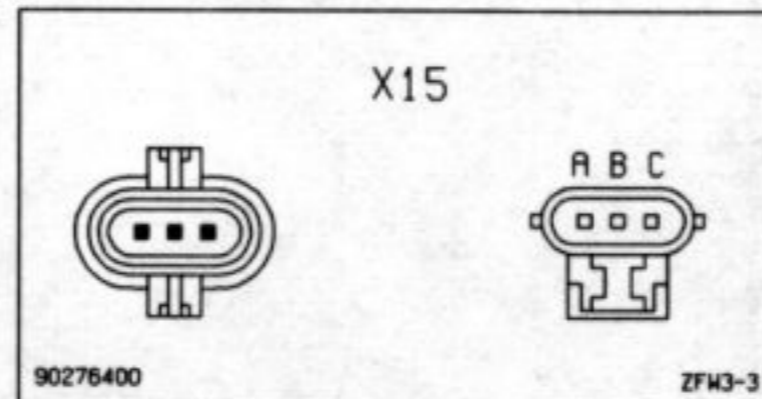
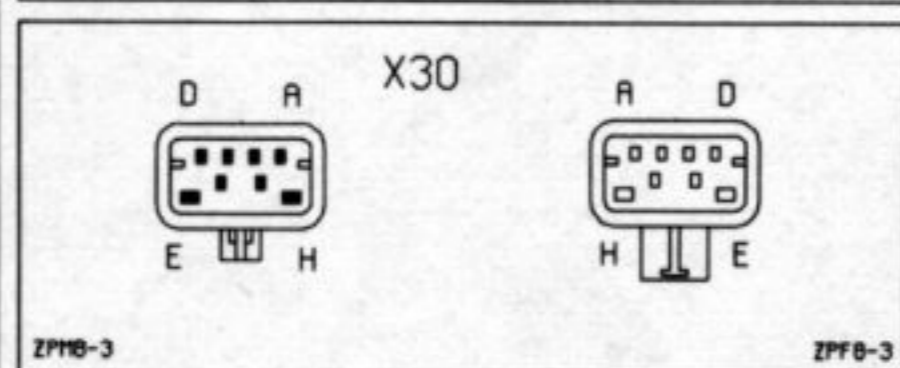
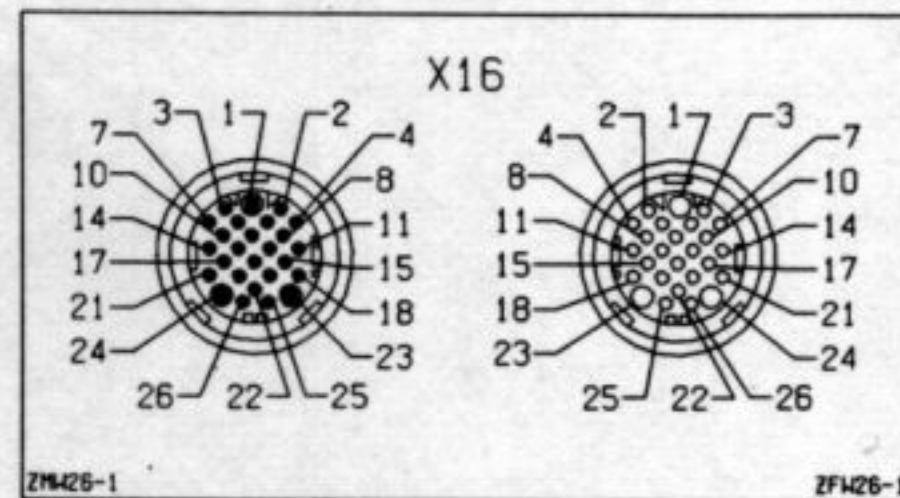
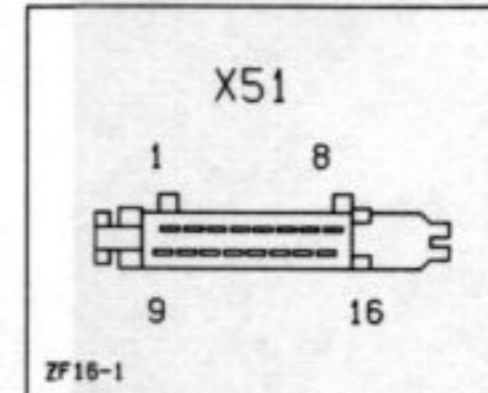
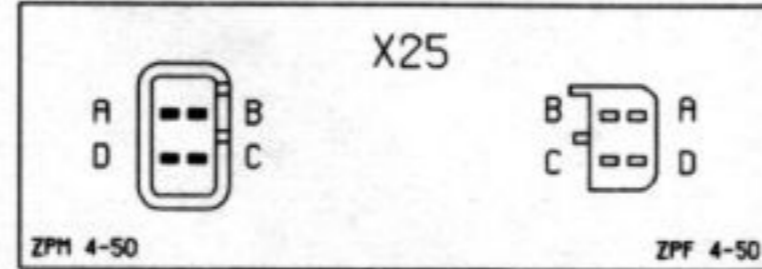
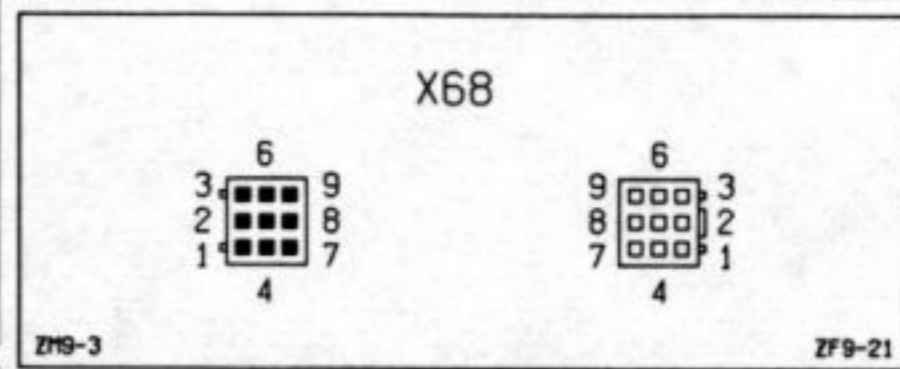
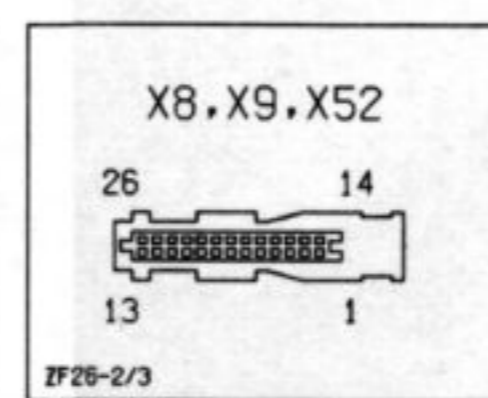
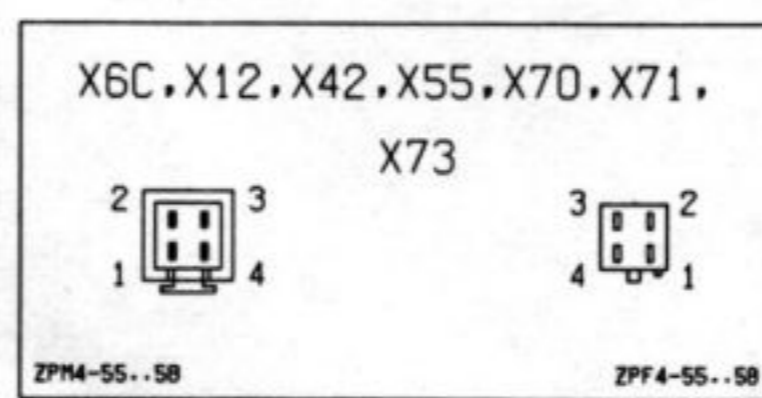
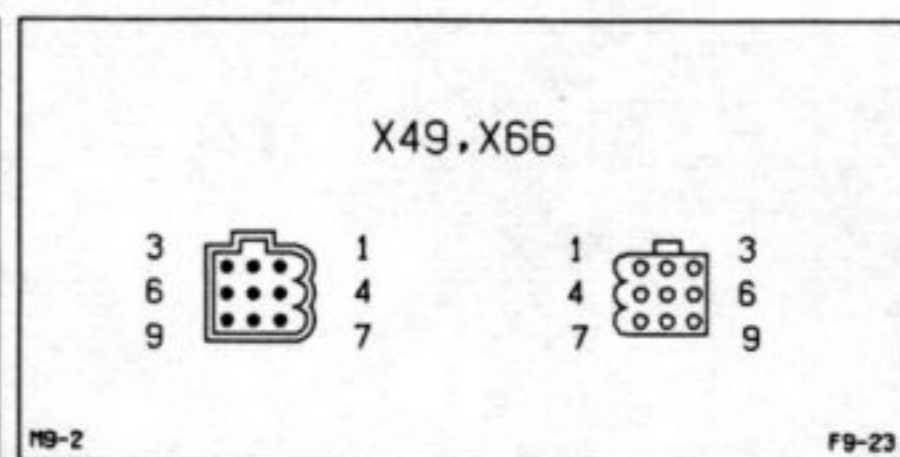
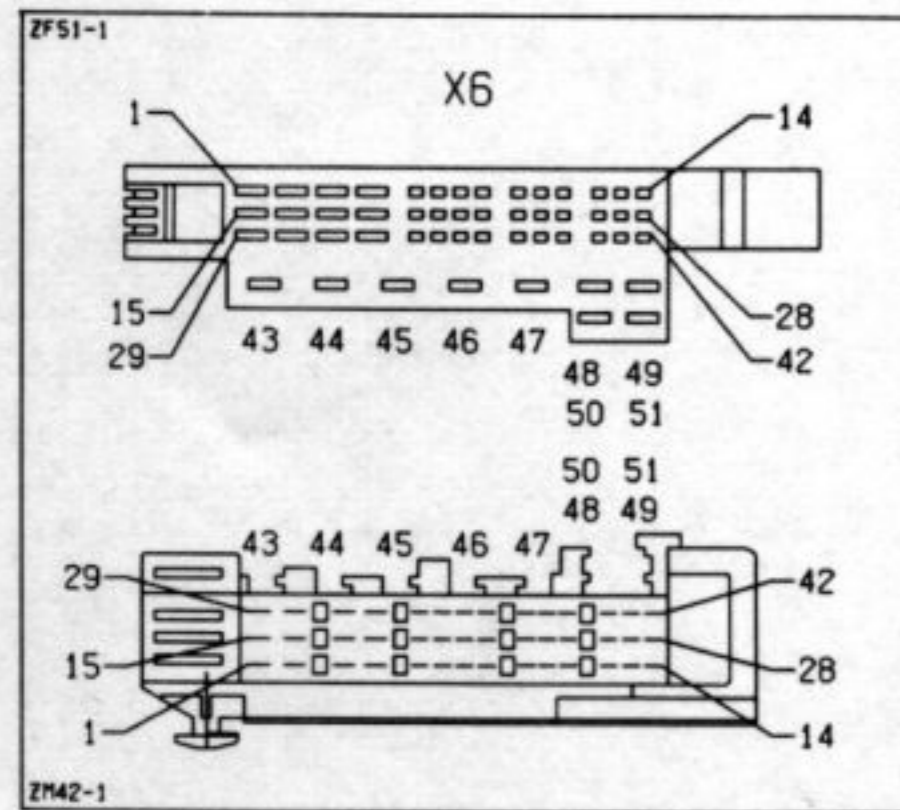

**STECKER UND STECKVERBINDUNGEN  
PLUGS AND PLUG CONNECTIONS**

- |     |   |   |
|-----|---|---|
| X1  | STECKDOSE-ANHÄNGER 7P                           | SOCKET-TRAILER 7P                                 |
| X5  | ARMATURENTAFEL & MOTOR 7P                       | INSTRUMENT PANEL & ENGINE 7P                      |
| X6  | ARMATURENTAFEL & KAROSSERIE 51P                 | INSTRUMENT PANEL & BODY 51P                       |
| X6A | ARMATURENTAFEL & KAROSSERIE 6P (BR)             | INSTRUMENT PANEL & BODY 6P (BR)                   |
| X6B | ARMATURENTAFEL & FAHRWERKABSTIMMUNG, HINTEN 6P  | INSTRUMENT PANEL & RIDE CONTROL, REAR 6P          |
| X6C | ARMATURENTAFEL & TÜR 4P                         | INSTRUMENT PANEL & DOOR 4P                        |
| X6D | KAROSSERIE & TÜR 6P (ZV)                        | BODY & DOOR 6P (ZV)                               |
| X7  | ARMATURENTAFEL & KLIMAPLANZE 7P                 | INSTRUMENT PANEL & AIR CONDITIONING 7P            |
| X8  | ARMATURENTAFEL & LCD-INSTRUMENT 26P             | INSTRUMENT PANEL & LCD-INSTRUMENT 26P             |
| X9  | ARMATURENTAFEL & LCD-INSTRUMENT 26P (CC)        | INSTRUMENT PANEL & LCD-INSTRUMENT 26P (CC)        |
| X10 | CODIERUNG-LÄENDER 6P                            | CODE-COUNTRIES 6P                                 |
| X11 | ARMATURENTAFEL & GEBER, TEMPERATUR 2P (KAT-J)   | INSTRUMENT PANEL & SENSOR, TEMPERATURE 2P (KAT-J) |
| X12 | CODIERUNG-DWA 4P                                | CODE-ANTI THEFT WARN U. 4P                        |
| X13 | DIAGNOSE LINK 10P                               | DIAGNOSTIC LINK 10P                               |
| X15 | OKTANZAHL 3P                                    | OCTANE NUMBER 3P                                  |
| X16 | ARMATURENTAFEL & MOTRONIC 26P                   | INSTRUMENT PANEL & MOTRONIC 26P                   |
| X17 | ARMATURENTAFEL & INSTRUMENT 14P                 | INSTRUMENT PANEL & INSTRUMENT 14P                 |
| X18 | ARMATURENTAFEL & INSTRUMENT 16P                 | INSTRUMENT PANEL & INSTRUMENT 16P                 |
| X20 | TÜR & TÜR, FAHRER 24P                           | DOOR & DOOR, DRIVER 24P                           |
| X21 | TÜR & TÜR, BEIFAHRENDEN 24P                     | DOOR & DOOR, CO-DRIVER 24P                        |
| X22 | TÜR & TÜR, HINTEN LINKS 11P                     | DOOR & DOOR, REAR LEFT 11P                        |
| X23 | TÜR & TÜR, HINTEN RECHTS 11P                    | DOOR & DOOR, REAR RIGHT 11P                       |
| X25 | KAROSSERIE & DECKEL-HECKRAUM 4P                 | BODY & LID-TRUNK 4P                               |
| X26 | KAROSSERIE & DECKEL-HECKRAUM 3P                 | BODY & TRUNK COMPARTMENT 3P                       |
| X27 | KAROSSERIE & WAGENHOHENREGULIERUNG 3P           | BODY & CAR LEVEL CONTROL 3P                       |
| X29 | WAGENHOHENREGULIERUNG & HOEHENGEBER 5P          | CAR LEVEL CONTROL & HEIGHT SENSOR 5P              |
| X30 | MOTRONIC & SCHALTER-AT 8P                       | MOTRONIC & SWITCH-AT 8P                           |
| X34 | MOTRONIC & KRAFTSTOFFEINSPRITZUNG 3P (C30SE)    | MOTRONIC & FUEL INJECTION 3P (C30SE)              |
| X35 | MOTRONIC & KRAFTSTOFFEINSPRITZUNG 15P (C26NE)   | MOTRONIC & FUEL INJECTION 15P (C26NE)             |
| X40 | KAROSSERIE & KONSOLE 8P (HT/AT)                 | BODY & CONSOLE 8P (HT/AT)                         |
| X42 | ARMATURENTAFEL & GESCHWINDIGKEITSREGLER 4P (AT) | INSTRUMENT PANEL & CRUISE CONTROL 4P (AT)         |
| X43 | ARMATURENTAFEL & KAROSSERIE 6P                  | INSTRUMENT PANEL & BODY 6P                        |
| X44 | KAROSSERIE & LAUTSPRECHER, HINTEN 6P            | BODY & LOUDSPEAKER, REAR 6P                       |
| X45 | TÜR & KONSOLE 5P                                | DOOR & CONSOLE 5P                                 |
| X46 | TÜR & KONSOLE 8P (FH)                           | DOOR & CONSOLE 8P (FH)                            |
| X47 | TÜR & KONSOLE 7P (FH)                           | DOOR & CONSOLE 7P (FH)                            |
| X49 | KAROSSERIE & STECKDOSE-ANHÄNGER 9P              | BODY & SOCKET-TRAILER 9P                          |
| X50 | MOTRONIC & AUTOMATIKGETRIEBE 10P                | MOTRONIC & AUTOMATIC TRANSMISSION 10P             |
| X51 | ARMATURENTAFEL & CHECK CONTROL 16P              | INSTRUMENT PANEL & CHECK CONTROL 16P              |
| X52 | ARMATURENTAFEL & CHECK CONTROL 26P              | INSTRUMENT PANEL & CHECK CONTROL 26P              |
| X54 | ARMATURENTAFEL & INSTRUMENT 8P (CC)             | INSTRUMENT PANEL & INSTRUMENT 8P (CC)             |
| X55 | ARMATURENTAFEL & TÜR 4P                         | INSTRUMENT PANEL & DOOR 4P                        |
| X66 | FAHRTTÜR & SCHALTER, AUSSENSPIEGEL 9P           | DRIVER DOOR & SWITCH, OUTSIDE MIRROR 9P           |
| X68 | ARMATURENTAFEL & TÜR 9P                         | INSTRUMENT PANEL & DOOR 9P                        |
| X69 | ARMATURENTAFEL & RADIO 16P                      | INSTRUMENT PANEL & RADIO 16P                      |
| X70 | TÜR & GEBER-DWA, FAHRERSEITE 4P                 | DOOR & SENSOR-A/THF WRNG U., DRIVER SIDE 4P       |
| X71 | TÜR & GEBER-DWA, BEIFAHRENDEN 4P                | DOOR & SENSOR-A/THF WRNG U., CO-DRIVER SIDE 4P    |
| X72 | MOTRONIC & AUTOMATIKGETRIEBE 2P                 | MOTRONIC & AUTOMATIC TRANSMISSION 2P              |
| X73 | ARMATURENTAFEL & SCHALTER-KICK DOWN 4P (LHD)    | INSTRUMENT PANEL & SWITCH-KICK DOWN 4P (LHD)      |
| X75 | ARMATURENTAFEL & SICHERHEITSKONTROLLE 2P        | INSTRUMENT PANEL & SAFETY CONTROL 2P              |
| X76 | ARMATURENTAFEL & MOTRONIC 2P                    | INSTRUMENT PANEL & MOTRONIC 2P                    |
| X77 | KLIMAPLANZE & GEBLÄSE, KUEHLER 3P               | AIR CONDITIONING & BLOWER, RADIATOR 3P            |
| X80 | MOTOR & MOTRONIC 2P (AT)                        | ENGINE & MOTRONIC 2P (AT)                         |
| X82 | ARMATURENTAFEL & SCHALTER, GEBLÄSE 2P           | INSTRUMENT PANEL & SWITCH, BLOWER 2P              |
| X84 | KAROSSERIE & GEBER-DREHZAHL, ABS 2P (VL)        | BODY & SENSOR-REVOLUTION, ABS 2P (VL)             |
| X85 | KAROSSERIE & GEBER-DREHZAHL, ABS 2P (VR)        | BODY & SENSOR-REVOLUTION, ABS 2P (VR)             |
| X86 | KAROSSERIE & GEBER-DREHZAHL, ABS 2P (HL)        | BODY & SENSOR-REVOLUTION, ABS 2P (HL)             |
| X87 | KAROSSERIE & GEBER-DREHZAHL, ABS 2P (HR)        | BODY & SENSOR-REVOLUTION, ABS 2P (RR)             |

■ NICHT GEZEICHNET/NOT SHOWN