

KABELSATZSCHEMA / WIRING HARNESS DIAGRAM (SIMPLIFIED)

SCHEINWERFER-RECHTS
HEADLAMP-RIGHT

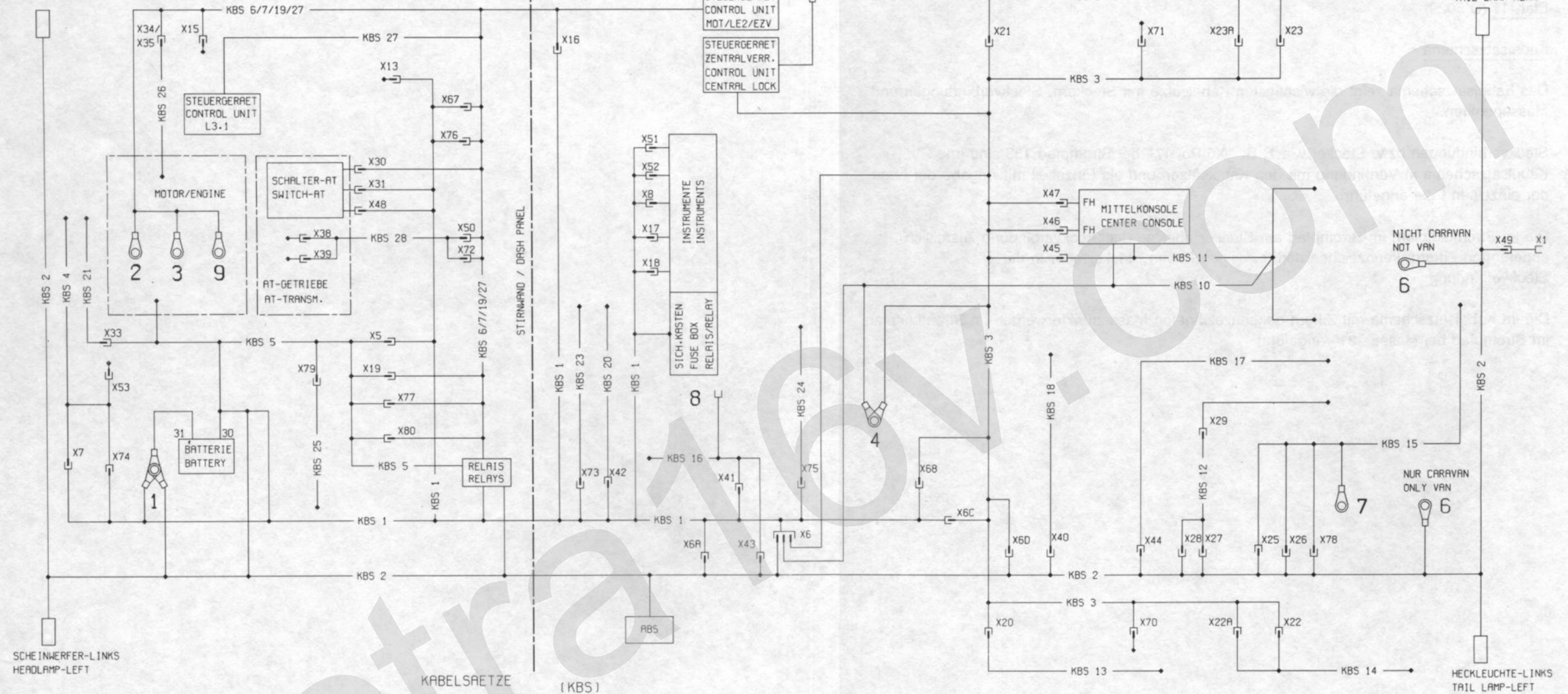

KABELSAETZE
WIRING HARNESSES (KBS)

- | | |
|---|--|
| KBS 1 = ARMATURENTAFEL
BODY | KBS 19 = EZV
CRUISE CONTROL |
| KBS 2 = KAROSSERIE
BODY | KBS 20 = GESCHWINDIGKEITSREGLER
BLOWER |
| KBS 3 = TUEER
DOOR | KBS 21 = GEBLAESE
BLOWER |
| KBS 4 = KLIMAMANLAGE
AIR CONDITIONING | KBS 22 = -----
SWITCH-KICK DOWN |
| KBS 5 = MOTOR
ENGINE | KBS 23 = SCHALTER-KICK DOWN
SAFETY CHECKING |
| KBS 6 = JETRONIC (LE2)
JETRONIC (LE2) | KBS 24 = SICHERHEITSKONTROLLE
ALTERNATOR (D) |
| KBS 7 = MOTRONIC
MOTRONIC | KBS 25 = GENERATOR (D)
VALVES, FUEL INJECTION |
| KBS 8 = BEIFAHRERTUEER
DOOR-REAR, RIGHT | KBS 26 = JETRONIC (L3.1)
JETRONIC (L3.1) |
| KBS 9 = TUEER-HINTEN, RECHTS
CONSOLE (WITHOUT WINDOW LIFTER) | KBS 27 = AUT. GETRIEBE AR 25/35
AUT. TRANSM. AR 25/35 |
| KBS 10 = KONSOLE (OHNE FENSTERHEBER)
CONSOLE (WITH WINDOW LIFTER) | |
| KBS 11 = KONSOLE (MIT FENSTERHEBER)
CAR LEVEL CONTROL | |
| KBS 12 = WAGENHOEHENREGULIERUNG
DRIVER DOOR | |
| KBS 13 = FAHRERTUEER
DOOR-REAR, LEFT | |
| KBS 14 = TUEER-HINTEN, LINKS
LID-TRUNK/TAIL GATE | |
| KBS 15 = DECKEL-HECKRAUM/KLAPPE-RUECKW.
RADIO | |
| KBS 16 = RADIO
LOUDSPEAKER-REAR, ANTENNA | |
| KBS 17 = LAUTSPRECHER-HINTEN, ANTENNE
AUTOMATIC TRANSMISSION-CONSOLE | |
| KBS 18 = AUTOMATIKGETRIEBE-KONSOLE
AUTOMATIC TRANSMISSION-CONSOLE | |

MASSEPUNKTE
GROUND POINTS 31-

- | | |
|---|---|
| 1 = KAROSSERIE-VORN.LINKS
BODY-FRONT, LEFT | 7 = KAROSSERIE-HINTEN, LINKS
BODY-REAR, LEFT |
| 2 = MOTOR-EINLASSKRUEMMER (LE2/MOT)
ENGINE-INTAKE MANIFOLD (LE2/MOT) | 8 = HALTER-LENKUNG
BRACKET-STEERING COLUMN |
| 3 = MOTOR-EINLASSKRUEMMER (MOT)
ENGINE-INTAKE MANIFOLD (MOT) | 9 = MOTOR-EINLASSKRUEMMER
ENGINE-INTAKE MANIFOLD |
| 4 = SEITENTEIL-STIRNPANDEL, LINKS
PANEL-SHROUD SIDE, LEFT | |
| 5 = SEITENTEIL-STIRNPANDEL, RECHTS
PANEL-SHROUD SIDE, RIGHT | |
| 6 = KAROSSERIE-HINTEN, MITTE/LINKS
BODY-REAR, CENTER/LEFT | |

STECKER UND STECKVERBINDUNGEN PLUGS AND PLUG CONNECTIONS

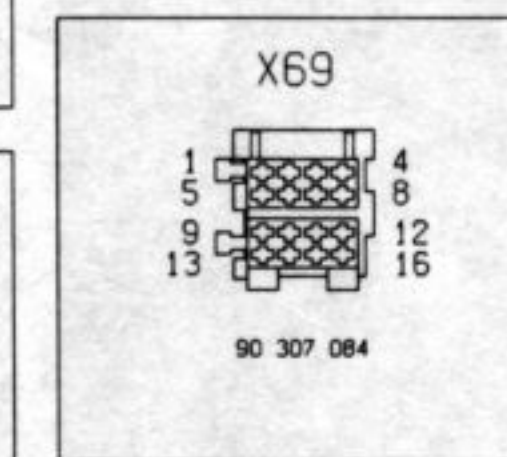
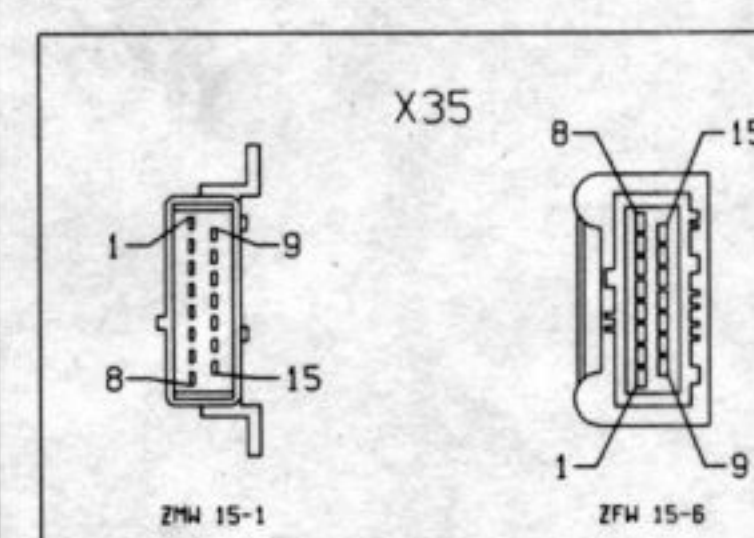
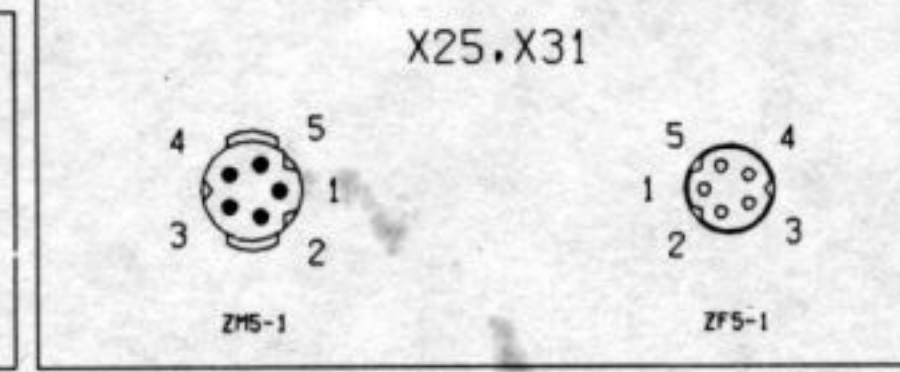
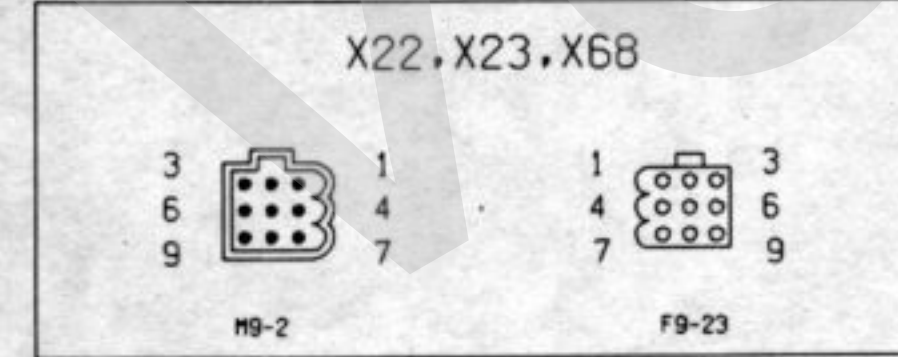
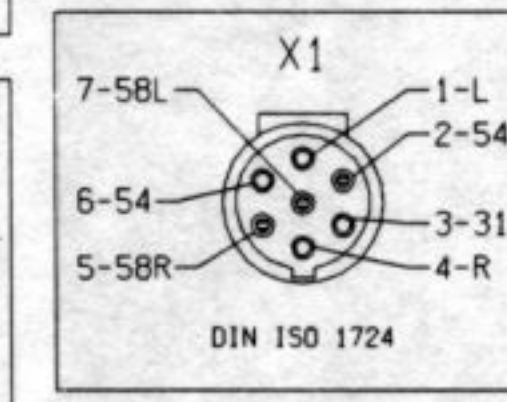
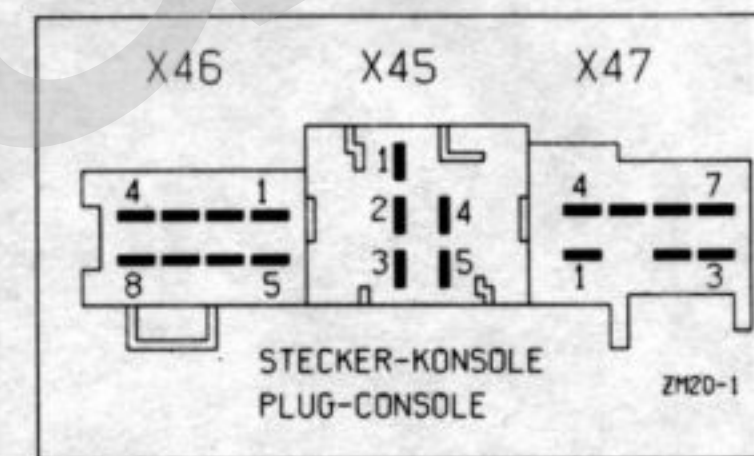
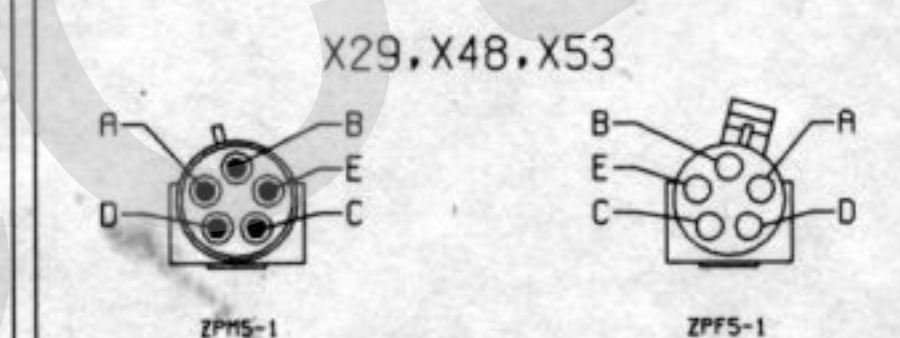
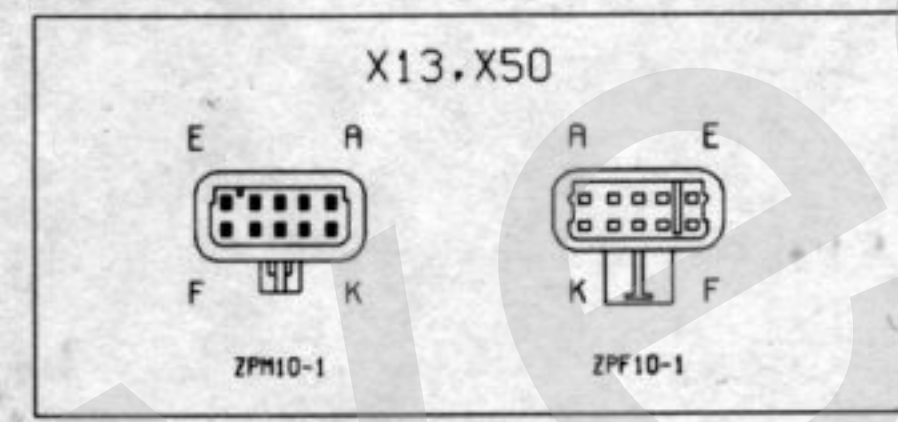
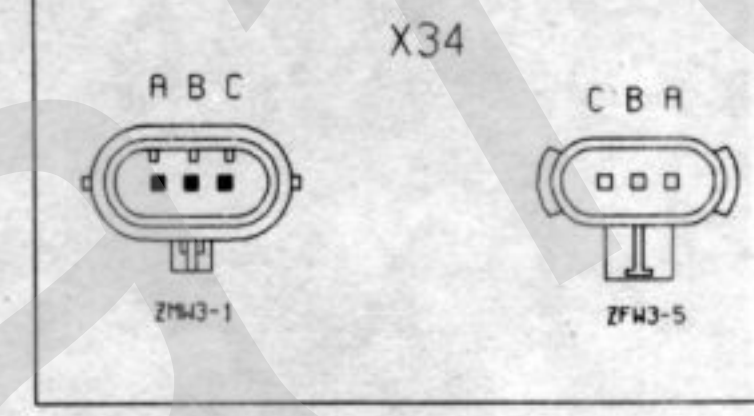
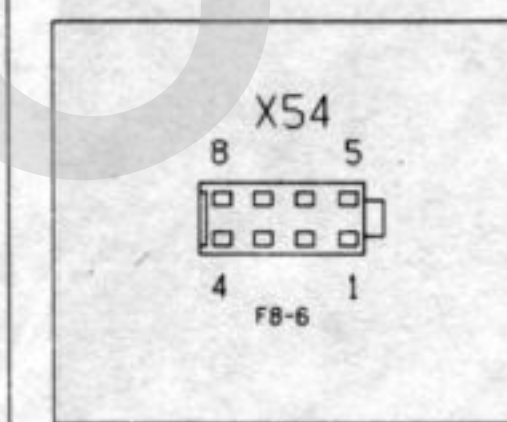
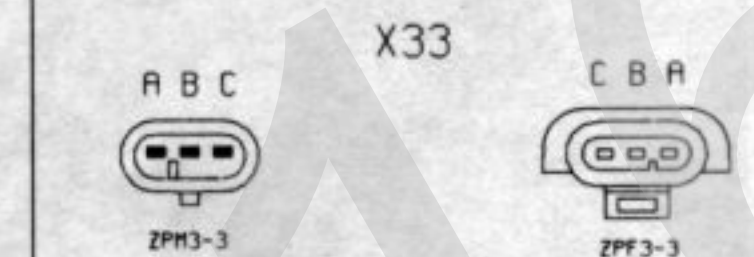
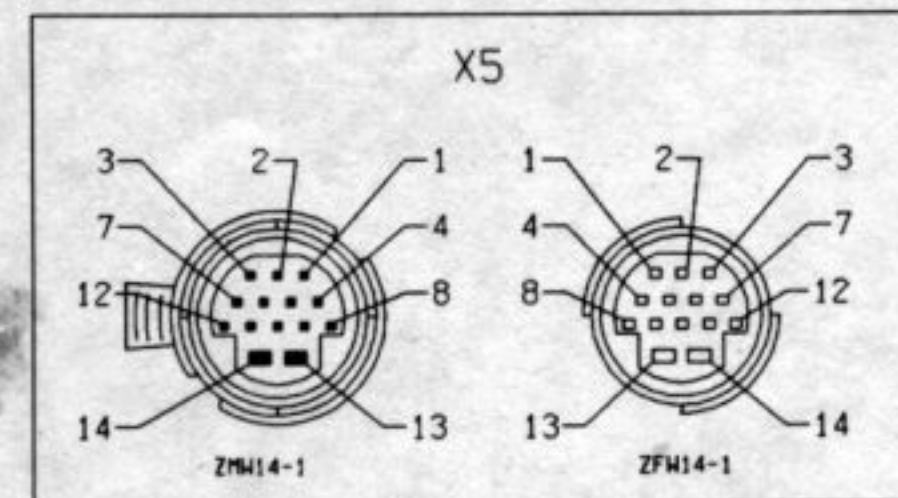
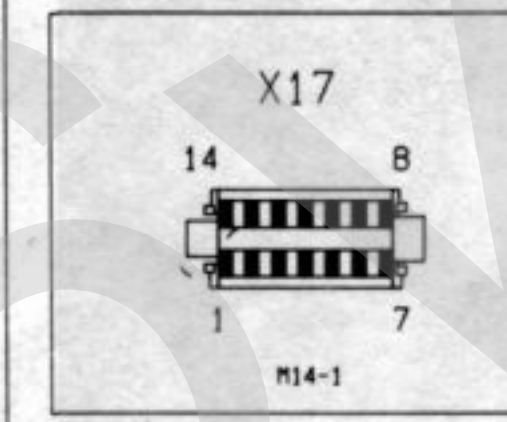
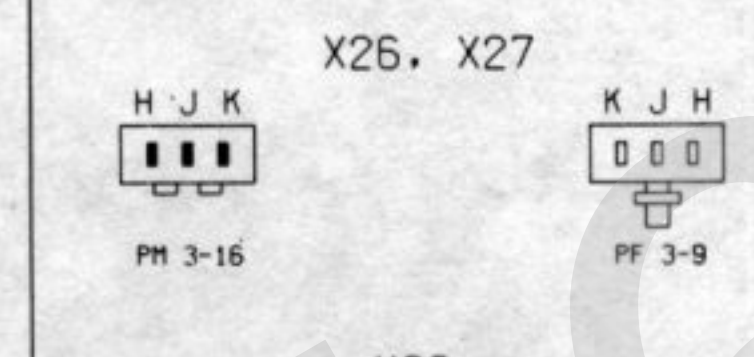
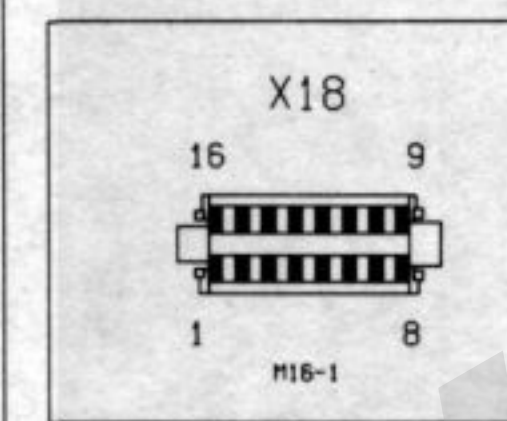
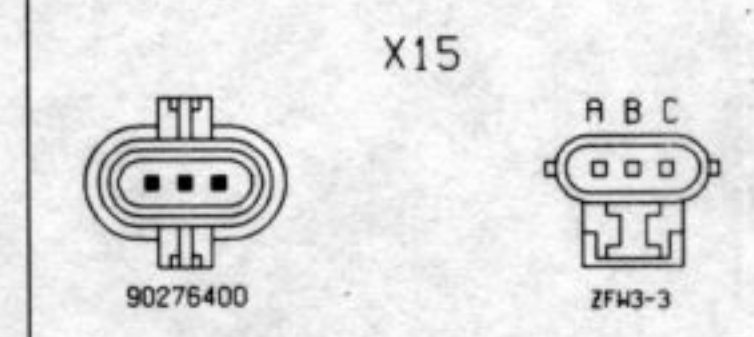
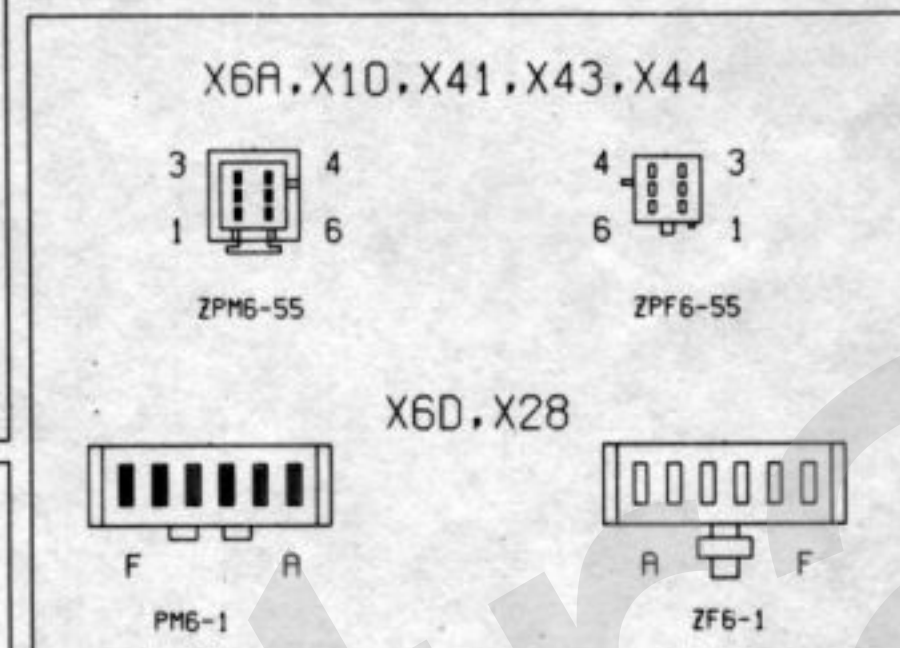
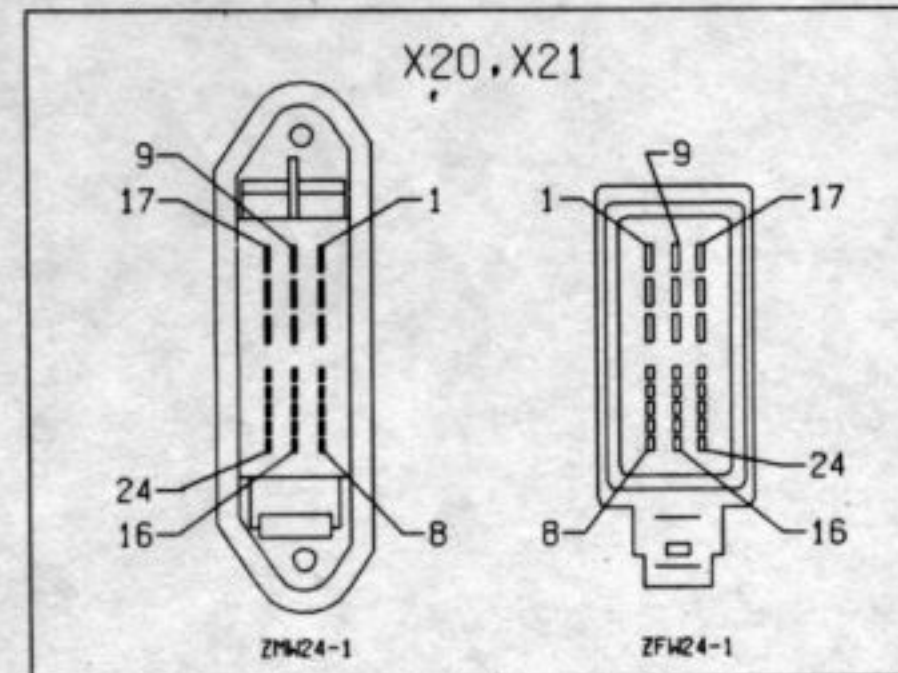
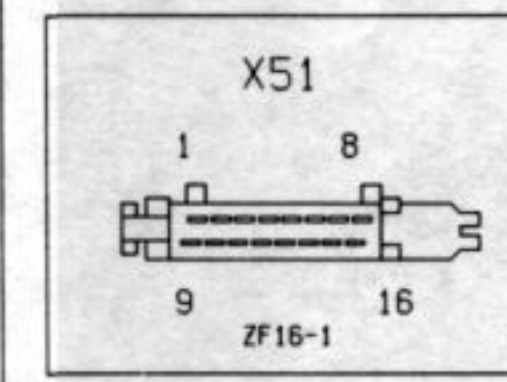
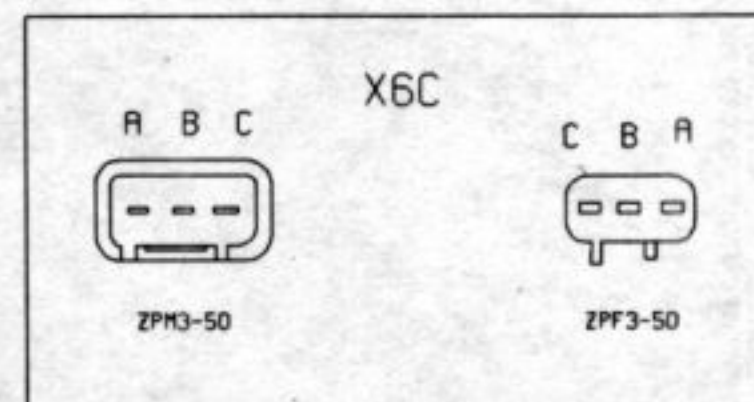
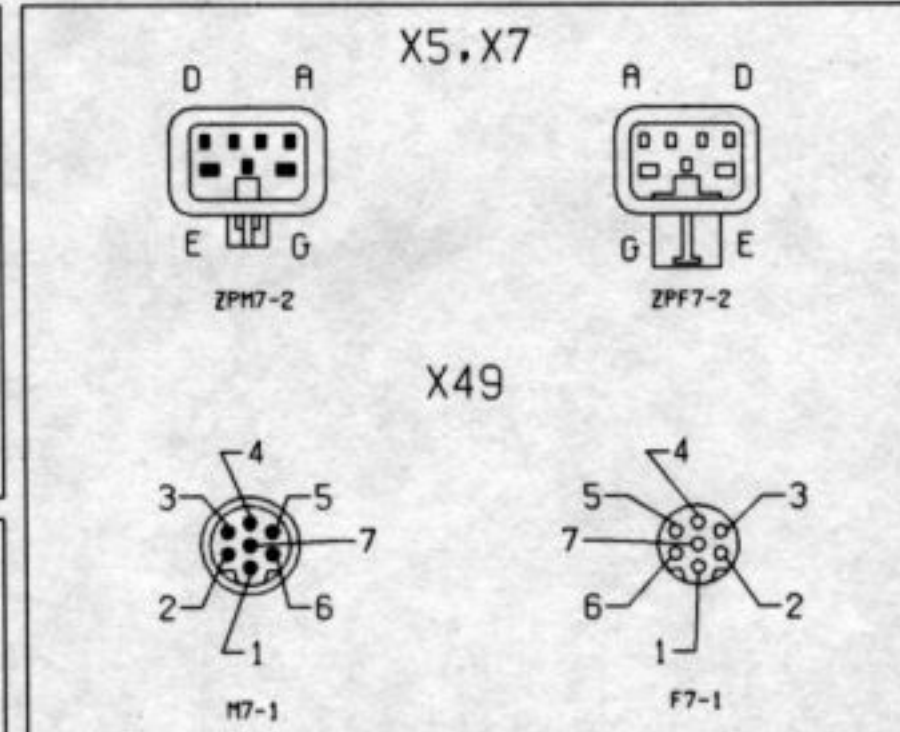
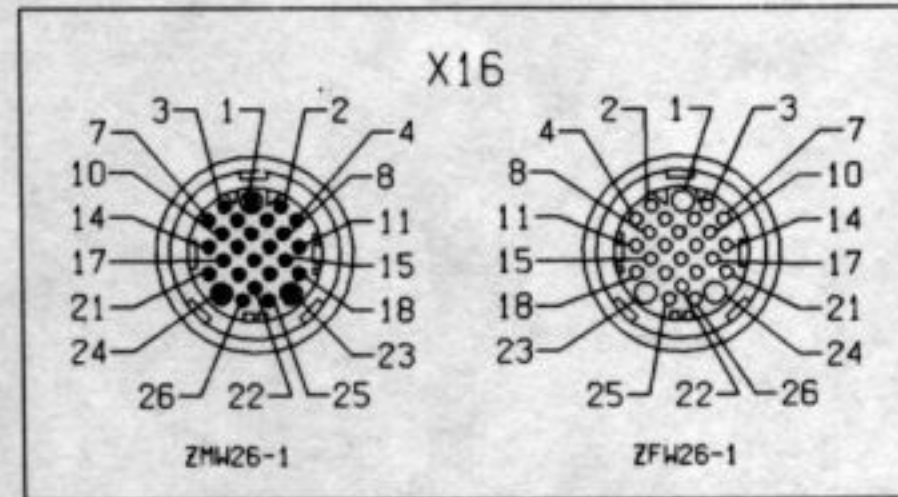
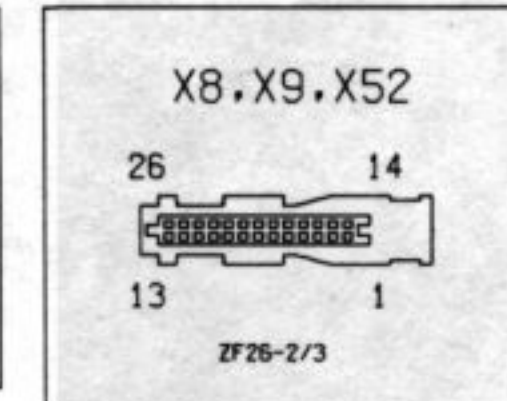
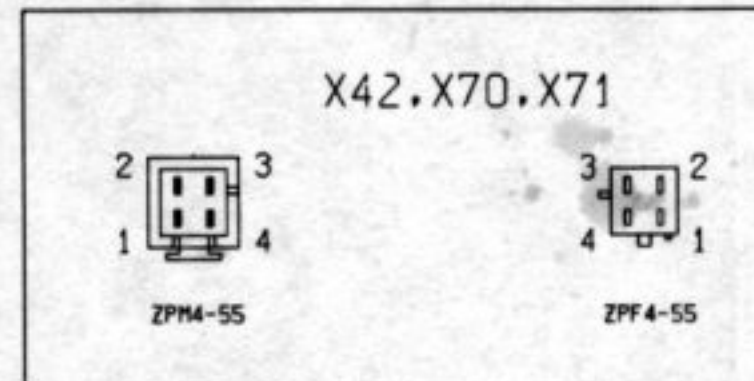
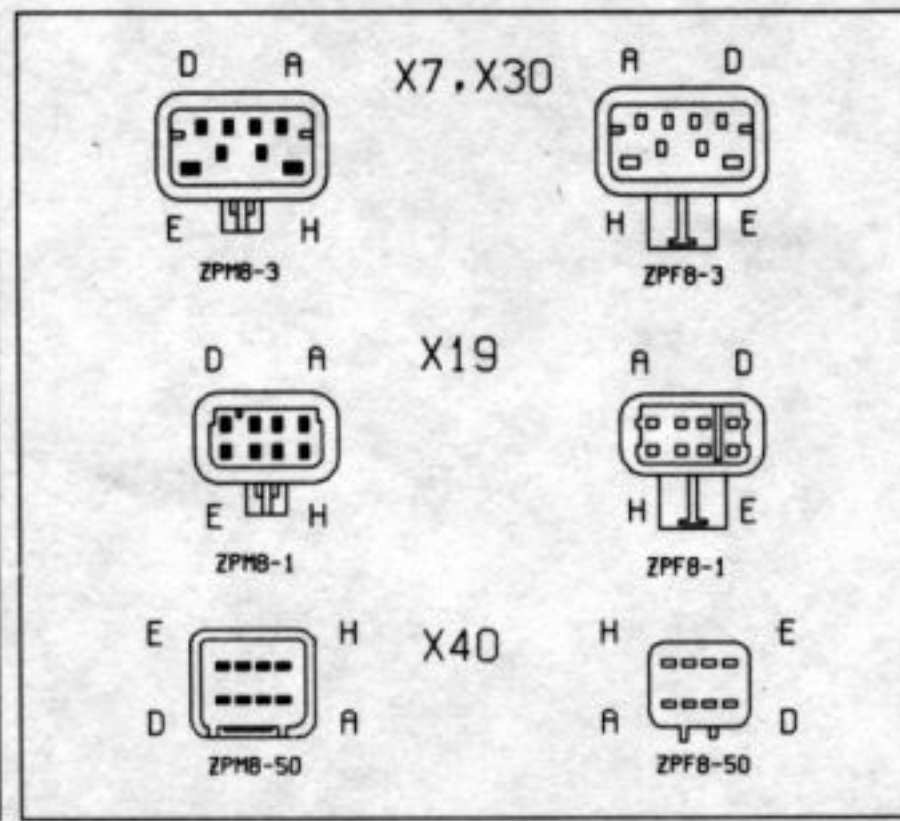
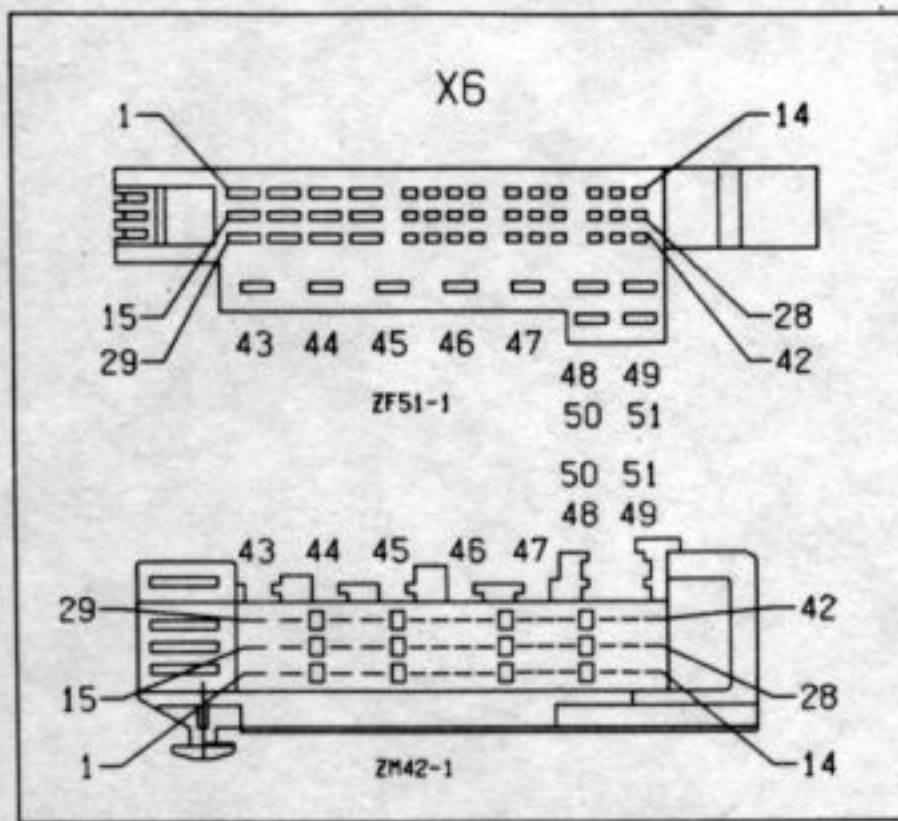

- | | | |
|------|--|--|
| X1 | STECKDOSE-ANHÄNGER 7P | SOCKET-TRAILER 7P |
| X5 | ARMATURENTAFEL & MOTOR 14P/7P-OMEGA 3000 | INSTRUMENT PANEL & ENGINE 14P/7P-OMEGA 3000 |
| X6 | ARMATURENTAFEL & KAROSSERIE 51P | INSTRUMENT PANEL & BODY 51P |
| X6A | ARMATURENTAFEL & KAROSSERIE 6P | INSTRUMENT PANEL & BODY 6P |
| X6C | ARMATURENTAFEL & TÜR 3P | INSTRUMENT PANEL & DOOR 3P |
| X6D | KAROSSERIE & TÜR 6P (ZV) | BODY & DOOR 6P (ZV) |
| X7 | ARMATURENTAFEL & KLIMANLAGE 7/8P-AT | INSTRUMENT PANEL & AIR CONDITIONING 7/8P-AT |
| X8 | LCD-INSTRUMENT 26P | LCD-INSTRUMENT 26P |
| X9 | LCD-INSTRUMENT 26P (CC) | LCD-INSTRUMENT 26P (CC) |
| X10 | CODIERUNG-LÄNDER 6P | CODE-COUNTRIES 6P |
| X13 | DIAGNOSE 10P | DIAGNOSTIC LINK 10P |
| X15 | OKTANZAHL 3P | OCTANE NUMBER 3P |
| X16 | ARMATURENTAFEL & MOTRONIC/JETRONIC/EZV 26P | INSTRUMENT PANEL & MOTRONIC/JETRONIC/EZV 26P |
| X17 | INSTRUMENT 14P | INSTRUMENT 14P |
| X18 | INSTRUMENT 16P | INSTRUMENT 16P |
| X19 | MOTOR & JETRONIC 8P | ENGINE & JETRONIC 8P |
| X20 | TÜR & TÜR, FAHRER 24P | DOOR & DOOR, DRIVER 24P |
| X21 | TÜR & TÜR, BEIFAHNER 24P | DOOR & DOOR, CO-DRIVER 24P |
| X22 | TÜR & TÜR, HINTEN LINKS 9P | DOOR & DOOR, REAR LEFT 9P |
| X22A | TÜR & TÜR, HINTEN LINKS 2P | DOOR & DOOR, REAR LEFT 2P |
| X23 | TÜR & TÜR, HINTEN RECHTS 9P | DOOR & DOOR, REAR RIGHT 9P |
| X23A | TÜR & TÜR, HINTEN RECHTS 2P | DOOR & DOOR, REAR RIGHT 2P |
| X25 | KAROSSERIE & DECKEL-HECKRAUM/KLAPPE-RUECKW. 5P | BODY & LID-TRUNK/TAILO GATE 5P |
| X26 | KAROSSERIE & KLAPPE-RUECKWAEND 3P | BODY & CAR LEVEL CONTROL 3P |
| X27 | KAROSSERIE & WAGENHOEHNREGULIERUNG 3P | BODY & CAR LEVEL CONTROL 3P |
| X28 | KAROSSERIE & WAGENHOEHNREGULIERUNG 6P | BODY & CAR LEVEL CONTROL 6P |
| X29 | WAGENHOEHNREGULIERUNG-HOEHENGEBER 5P | CAR LEVEL CONTROL-HEIGHT SENSOR 5P |
| X30 | MOTRONIC/JETRONIC & SCHALTER-AT 8P | MOTRONIC/JETRONIC & SWITCH-AT 8P |
| X31 | ARMATURENTAFEL & SCHALTER-AT 5P | INSTRUMENT PANEL & SWITCH-AT 5P |
| X32 | KLIMANLAGE & MOTOR 1P (D) | AIR CONDITIONING & ENGINE 1P (D) |
| X33 | MOTOR & DEBLAESE 3P | ENGINE & BLOWER 3P |
| X34 | MOTRONIC & VENTILE-KRAFTSTOFFEINSPR. 3P (C30SE) | MOTRONIC & VALVES-FUEL INJECTION 3P (C30SE) |
| X35 | MOTRONIC & VENTILE-KRAFTSTOFFEINSPR. 15P (C26NE) | MOTRONIC & VALVES-FUEL INJECTION 15P (C26NE) |
| X36 | MOTRONIC & MOTOR 1P (C24NE) | MOTRONIC & ENGINE 1P (C24NE) |
| X40 | KAROSSERIE & AUTOMATIKGETRIEBE-KONSOLE 8P | BODY & AUTOMATIC TRANSMISSION-CONSOLE 8P |
| X41 | ARMATURENTAFEL & RADIO 6P | INSTRUMENT PANEL & RADIO 6P |
| X42 | ARMATURENTAFEL & GESCHWINDIGKEITSREGLER 4P | INSTRUMENT PANEL & CRUISE CONTROL 4P |
| X43 | KAROSSERIE & RADIO 6P | BODY & RADIO 6P |
| X44 | KAROSSERIE & LAUTSPRECHER, HINTEN 6P | BODY & LOUDSPEAKER, REAR 6P |
| X45 | TÜR & KONSOLE 5P | DOOR & CONSOLE 5P |
| X46 | TÜR & KONSOLE 8P (FH) | DOOR & CONSOLE 8P (FH) |
| X47 | TÜR & KONSOLE 7P (FH) | DOOR & CONSOLE 7P (FH) |
| X48 | ARMATURENTAFEL & SCHALTER-AT 5P | INSTRUMENT PANEL & SWITCH-AT 5P |
| X49 | KAROSSERIE & STECKDOSE-ANHÄNGER 7P | BODY & SOCKET-TRAILER 7P |
| X50 | MOTRONIC/JETRONIC & AUTOMATIKGETRIEBE 10P | MOTRONIC/JETRONIC & AUTOMATIC TRANSMISSION 10P |
| X51 | SYSTEMUEBERWACHUNG 16P | CHECK CONTROL 16P |
| X52 | SYSTEMUEBERWACHUNG 26P | CHECK CONTROL 26P |
| X53 | KLIMANLAGE & KOMPRESSOR 5P (D) | AIR CONDITIONING & COMPRESSOR 5P (D) |
| X54 | INSTRUMENT 8P (CC) | INSTRUMENT 8P (CC) |
| X67 | ARMATURENTAFEL & MOTRONIC/JETRONIC 5P | INSTRUMENT PANEL & MOTRONIC/JETRONIC 5P |
| X68 | ARMATURENTAFEL & TÜR 9P | INSTRUMENT PANEL & DOOR 9P |
| X69 | RADIO 16P | RADIO 16P |
| X70 | TÜR & GEBER-DWA, FAHRERSEITE 4P | DOOR & SENSOR-A/THF WRNG U., DRIVER SIDE 4P |
| X71 | TÜR & GEBER-DWA, BEIFAHNERSEITE 4P | DOOR & SENSOR-A/THF WRNG U., CO-DRIVER SIDE 4P |
| X72 | MOTRONIC & AUTOMATIKGETRIEBE 2P | MOTRONIC & AUTOMATIC TRANSMISSION 2P |
| X73 | ARMATURENTAFEL & SCHALTER-KICK DOWN 2P | INSTRUMENT PANEL & SWITCH-KICK DOWN 2P |
| X74 | ARMATURENTAFEL & KLIMANLAGE 2P | INSTRUMENT PANEL & AIR CONDITIONING 2P |
| X75 | ARMATURENTAFEL & SICHERHEITSKONTROLLE 2P | INSTRUMENT PANEL & SAFETY CONTROL 2P |
| X76 | ARMATURENTAFEL & MOTRONIC/JETRONIC 2P | INSTRUMENT PANEL & MOTRONIC/JETRONIC 2P |
| X77 | MOTOR & EZV 2P | ENGINE & EZV 2P |
| X78 | KAROSSERIE & KLAPPE-RUECKWAEND 2P | BODY & TAIL GATE 2P |
| X79 | MOTOR & GENERATOR 2P (D) | ENGINE & ALTERNATOR 2P (D) |
| X80 | MOTOR & MOTRONIC/JETRONIC 2P (AT) | ENGINE & MOTRONIC/JETRONIC 2P (AT) |
| X81 | ARMATURENTAFEL & WASCHER-DUESEN, HEIßBAR 2P | INSTRUMENT PANEL & WASHER-NOZZLES, HEATED 2P |
| X83 | ARMATURENTAFEL & GESCHWINDIGKEITSREGLER 1P | INSTRUMENT PANEL & CRUISE CONTROL 1P |
| X84 | GEBER-DREHZAHN, ABS 2P (VORN LINKS) | SENSOR-REVOLUTION, ABS 2P (FRONT LEFT) |
| X85 | GEBER-DREHZAHN, ABS 2P (VORN RECHTS) | SENSOR-REVOLUTION, ABS 2P (FRONT RIGHT) |
| X86 | GEBER-DREHZAHN, ABS 2P (HINTEN LINKS) | SENSOR-REVOLUTION, ABS 2P (REAR LEFT) |
| X87 | GEBER-DREHZAHN, ABS 2P (HINTEN RECHTS) | SENSOR-REVOLUTION, ABS 2P (REAR RIGHT) |
| X88 | GESCHWINDIGKEITSREGLER & SCHALTER-AT 1P (AW71L) | CRUISE CONTROL & SWITCH-AT 1P (AW71L) |
| X89 | KLAPPE-RUECKWAEND & LEUCHE KENNZEICHEN 1P | TAIL GATE & LIGHT-LICENCE PLATE 1P |

* NICHT GEZEICHNET / NOT SHOWN